

NO: **R158**

COUNCIL DATE: **July 9, 2012**

---

## REGULAR COUNCIL

TO: **Mayor & Council**

DATE: **July 9, 2012**

FROM: **General Manager, Planning and Development**

FILE: **7911-0267-00**

SUBJECT: **Heritage Revitalization Agreement Amendment and Heritage Alteration Permit - Application No. 7911-0267-00  
Daniel Johnson House – 13951 Crescent Road**

---

## RECOMMENDATIONS

The Planning and Development Department recommends that Council:

1. Receive this report as information;
2. Approve amendments, as documented in Schedule 1 of Appendix I of this report, to the Heritage Revitalization Agreement (HRA) related to the Daniel Johnson House;
3. Authorize the City Clerk to bring forward for the required readings the necessary amendment by-law related to the HRA referenced above, schedule the related Public Hearing, and file the appropriate notice at the Land Title Office and with the appropriate Provincial Minister in accordance with the requirements of Section 966 of the *Local Government Act*; and
4. Authorize staff to draft Heritage Alteration Permit No. 7911-0267-00 in accordance with the plans attached as Appendix II to this report.

## PURPOSE

The purpose of this report is to obtain Council approval to amend the Heritage Revitalization Agreement (the "HRA") related to the Daniel Johnson House (the "Johnson House") and to draft a Heritage Alteration Permit ("HAP") to allow for the reconstruction of the Johnson House, which was destroyed by fire in December 2010, to allow the construction of an addition to the Johnson House, and to allow for the construction of accessory buildings on the property on which the Johnson House is located.

## BACKGROUND

### History and Heritage Value of the Johnson House

The Johnson House, located at 13951 Crescent Road (Appendix III), was built in 1904 and was included in the Surrey Heritage Register in 1998. The House is located on a lot that has an area of 6640.8 sq. m. [71481 sq. ft.] (1.65 acre) and is zoned One-Acre Residential (RA). The House is

governed by Heritage Revitalization Agreement (HRA) By-law, 2000, No. 14203, a copy of which is attached as Appendix IV.

The House is a symmetrical two-storey Edwardian era house, which takes its name from one of the first settlers in the area. Daniel Johnson, who originally homesteaded in Mud Bay on the Serpentine River in 1880, later moved to the banks of the Nicomekl River on Crescent Road to expand his successful dairy operation. The house he built there, which was later relocated onto a property to the west, serves as a reminder of the agriculture-based roots of the community and the scale of housing and development, which reflected the success of the early farming communities of Surrey.

Daniel Johnson is important to the history of Surrey, not only because he is one of the pioneering settlers of the area, but also for his well-known large dairy farming operation and for the construction of his prominent home in Elgin.

The Johnson House is an example of a grand Edwardian farmhouse. Sitting on a rectangular plan, the house has a large wraparound veranda with classically influenced ornamentation and architectural details, the scale of which reflects Daniel Johnson's successes. The fenestration and ornamentation also reinforce the strong design of the house and the unusual nature of a carefully decorated rural farmhouse.

The Nicomekl River borders the side of the property opposite Crescent Road. The House's location along a body of water also demonstrates the importance of water to agricultural ventures, in particular Johnson's dairy farm.

Key elements that define the heritage character of the Johnson House include its:

- location on along the Nicomekl River;
- form, scale, and massing;
- large wraparound veranda encircling the house with wood railing and square balusters;
- hip roof with dormers;
- rectangular double-hung 1-over-1 wooden-sash windows, in single, double and triple arrangement;
- second floor windows above the main entry, which feature triplet rectangular fixed sash windows with hexagon and diamond patterns;
- oval fixed wooden-sash window with keystone motif in the surrounding frame; and
- entrance pediment centred on the veranda roof with flanking veranda posts and corresponding decorative beams.

In 1977, the property on which the Johnson House was located was redeveloped as part of the Nico Wynd townhouse and golf course development. At that time, the Johnson House was moved west to its current location at 13951 Crescent Road. The orientation of the Johnson House at its new location was similar to its original orientation, i.e., originally the front faced southeast and in its relocated position it faced approximately due east.

#### **HRA By-law, 2000, No. 14203**

In January 1997, Council approved the purchase of the Daniel Johnson House and a neighbouring property at 13931 Crescent Road to achieve the following objectives:

1. The provision of a continuous greenway, connecting the park trails along Elgin Heritage Park to the west with those located on an existing right of way around the Nico Wynd golf course to the east; and
2. The protection of environmentally sensitive areas along the Nicomekl River waterfront.

The two lots were subdivided into three with one of the lots being along the Nicomekl River. The lot fronting the Nicomekl River was retained by the City to achieve public access along the riverfront and to protect the environmentally sensitive areas on the waterfront. The other two residential lots fronting Crescent Road, one of which contained the Johnson House, were sold. Prior to the Johnson House being sold, an HRA was registered on the title of the property to ensure the protection of the Johnson House. The related By-law, HRA By-law, 2000, No. 14203, is attached as Appendix IV to this report.

There are several provisions within the HRA that serve to restrict the nature and scope of development on the property:

1. The HRA defines lands outside of the "Restricted Building Envelope" (see page A-16 of Appendix IV) as "lands in the opinion of the City necessary for the conservation of proximate improvements, identified in the Conservation Plan as having *heritage value* and *heritage character*..." It states that these lands are "to remain free of all development and shall be kept in their landscaped and cultivated state..." The property is subject to increased setback restrictions that define the "Restricted Building Envelope".
2. In the event the House is more than 50% destroyed, the HRA requires the Johnson House to be reconstructed in a massing and style similar to, but not necessarily identical to, the existing House. The HRA requires that the design of the reconstructed house capture the original design components including: roof pitch, roofing material, roof lines including gables, wood cladding, window style and placement, wrap-around porch, and location of entrances.
3. The HRA allows the Johnson House to be moved from its present location onto a new concrete foundation on the same lot. The location of the relocated house on the lands is restricted by the setbacks for the One-Acre Residential (RA) Zone specified in Schedule "B" of the HRA. If the House is placed on a new foundation, the HRA requires that the new elevation be lower than the existing elevation, and the foundation not extend more than 1 metre (3 ft.) above the finished grade. The HRA also requires that if the Johnson House is moved onto a new foundation the existing basement garage not be retained and any new garage be detached from the house.
4. The Conservation Plan attached to the HRA includes the following requirements:
  - Installation of a new edge-cut cedar shingle roof;
  - Retention/replacement as necessary of all wood detailing including siding;
  - Retention/restoration of original wood windows;
  - Use of seamless pre-finished aluminum O-Gee profile eaves troughs and pre-finished aluminum downspouts, preferably in circular profile; and
  - Rebuilding of the red brick chimney.
5. The HRA allows for a detached one or two-car garage to be built on the property in accordance with the requirements for an accessory building specified in Schedule "B" of the

HRA. The HRA requires the garage be built in a style identical to the Johnson House. This includes, but is not limited to a roof peak running lengthwise along the garage, flared roof ends, roofing material, eaves troughs, downspouts and associated fascia. The garage is to be clad with wood lap siding. The garage door is to be of solid wood construction, either double batten doors, or single-car conventional wooden garage doors on tracks and rollers. Windows are to be provided on at least two sides of the garage. The windows are to appear similar to the double hung windows of the House.

6. The HRA states that "The construction or alteration of any improvements on the Lands so as to create a secondary suite or suite of any kind whether for use by the owner or otherwise shall not be permitted".
7. Schedule "B" of the HRA sets out amendments to Part 12, One-Acre Residential Zone (RA) of City of Surrey Zoning By-law, 1993, No. 12000, with respect to the Lands. This includes restrictions to floor area ratio, allowable floor area, setbacks, and subdivision. Other details are provided in Schedule "B" of Appendix IV attached to this report.

### **Destruction of the Daniel Johnson House**

On December 17, 2010, a fire destroyed the Daniel Johnson House. The fire was so severe that no further documentation of the House was possible.

### **DISCUSSION**

#### **Proposed Amendment to the Heritage Revitalization Agreement and the Related Heritage Alteration Permit**

As noted above, the HRA for the Johnson House requires the House to be rebuilt in the event it is destroyed. The owners of the Johnson House have applied to the City for an amendment to the HRA and an HAP to allow for the reconstruction of the Johnson House, the construction of an addition to the House, and the construction of accessory buildings on the property (for detailed plans, please see Appendix II).

Under Section 966 of the *Local Government Act*, an HRA may vary or supplement the Zoning By-law. In addition to amending restrictions within the existing HRA, the applicants are proposing to incorporate several Zoning By-law variances within the amended HRA.

The proposal and required HRA amendments are summarized in the following table.

| <b>Proposal</b>  | <b>Required HRA amendments</b>  |
|--|---|
| Reconstruct the Johnson House in its original scale, proportions, size, and materials in accordance with the HRA.  | HRA amendment to incorporate a Zoning By-law variance to increase the maximum height for a principal building in the RA Zone from 9.0 metres [30 ft.] to 12.53 metres [41.11 ft.].  |
| Rotate the Johnson House on the property so that it faces south (Crescent Road) rather than east (neighbouring parking lot) to take advantage of river views.  | None.   |
| Move the Johnson House north on the property partially outside of the "Restricted Building Envelope" to allow sufficient area for the construction of detached garage and to take advantage of river views.  | HRA amendment to allow the Johnson House to encroach 8.53 m. [28 ft.] into the restricted rear yard setback. The proposed 20.5 m [67 ft.] setback is permitted in the RA Zone.  |
| Construct an approximately 138 sq. m. [1481 sq. ft.] addition on the west side of the Johnson House to replace floor area previously in the basement. Due to the potential for flooding on the property, the approximately 186 sq. m. [1,998 sq. ft.] basement will <u>not</u> be reconstructed. | HRA amendment to allow the restricted floor area for the House (325 sq. m. [3,500 sq. ft.]) to be increased. The proposed increase in floor area (118 sq. m. [+1269 sq. ft.]) is permitted in the RA Zone.  |
| Construct a 110 sq. m. [1,184 sq. ft.] detached three-car garage to replace the two-car garage that was previously located in the basement of the House.   | HRA amendment to allow the restricted floor area for the garage (50 sq. m. [540 sq. ft.]) to be increased. The proposed increase in floor area (60 sq. m. [646 sq. ft.]) is permitted in the RA Zone.   |
| Construct a 58 sq. m. [623 sq. ft.] accessory dwelling unit above the detached garage.   | <p>HRA amendment to permit the construction of a "suite" on the property (currently prohibited by the HRA) and to include an accessory dwelling unit as a permitted use in the RA Zone.</p> <p>HRA amendment to allow the total restricted floor area (375 sq. m. [4040 sq. ft.]) to be increased. The proposed increase in floor area (58 sq. m. [623 sq. ft.]) is permitted in the RA Zone.</p> <p>HRA amendment to incorporate a Zoning By-law variance to increase the maximum height for an accessory building in the RA Zone from 5.0 metres [16 ft.] to 6.02 metres [19.75 ft.] where an accessory dwelling unit is located above an accessory building.</p> |
| Construct a 56 sq. m. [600 sq. ft.] accessory building (pool house) adjacent to the existing pool.   | HRA amendment to allow the total restricted floor area (375 sq. m [4040 sq. ft.]) to be increased. The proposed increase in floor area (56 sq. m. [600 sq. ft.]) is permitted in the RA Zone.   |
| Remove third floor addition and balcony from east elevation (later additions) to allow the original roofline to be reinstated.   | None.   |
| Add projecting hip roof dormer on the east elevation to replace above-noted addition in a more sensitive manner.   | None.   |
| Lower the Johnson House to no more 1 m. (3 ft.) above finished grade in accordance with the HRA.   | None.   |
| Paint the Johnson House and accessory buildings in an approved colour scheme from the Benjamin Moore Historic True Colours palette.  | None.   |
| Install landscaping in accordance with the HRA.  | None.   |

HRA By-law, 2000, No. 14203 restricts the floor area ratio (F.A.R.) on the Johnson House property to 0.056. As the above-noted proposal involves the addition of 3135 sq. ft. [291 sq. ft.] to the property (over and above the restricted floor area), an HRA amendment will be required to increase the permitted F.A.R. to 0.10.

The application for an HRA amendment and a HAP, related to the Johnson House, was referred to the Heritage Advisory Commission (the "HAC") on March 18, 2012. The HAC recommended that:

- "(a) the proposed amendments to HRA By-law, 2000, No. 14203 be forwarded to Council for consideration; and*
- (b) staff seek Council's approval to draft a Heritage Alteration Permit (HAP) for rebuilding the Daniel Johnson House, constructing an addition to the House, and constructing accessory buildings on the property" ..*

The plans attached as Appendix II have been reviewed by the City Architect, Engineering Department, and Parks, Recreation and Culture Department.

Legal Services has reviewed the proposed amendments to HRA By-law, 2000, No. 14203 and has no concerns.

## **SUSTAINABILITY CONSIDERATIONS**

SC10: Historical and Heritage Assets, focused on protecting Surrey's heritage assets.

## **CONCLUSION**

Based on the above discussion, it is recommended that Council:

- Approve amendments, as documented in Schedule 1 of Appendix I of this report, to the Heritage Revitalization Agreement (HRA) related to the Daniel Johnson House;
- Authorize the City Clerk to bring forward for the required readings the necessary amendment by-law related to the HRA referenced above, schedule the related Public Hearing, and file the appropriate notice at the Land Title Office and with the appropriate Provincial Minister in accordance with the requirements of Section 966 of the *Local Government Act*; and

- Authorize staff to draft Heritage Alteration Permit No. 7911-0267-00 in accordance with the plans attached as Appendix II to this report.

*Original signed by*  
Jean Lamontagne  
General Manager  
Planning and Development

ES/kms/saw

Attachments:

|              |   |
|--------------|---|
| Appendix I   | A by-law to amend the provisions of HRA By-law, 2000, No. 14203 |
| Appendix II  | Proposed Plans for the Daniel Johnson House and Property        |
| Appendix III | Location Map: 13951 Crescent Road                               |
| Appendix IV  | Heritage Revitalization Agreement By-law, 2000, No. 14203       |

CITY OF SURREY

BY-LAW NO.

A by-law to amend the provisions of "City of Surrey  
Heritage Revitalization Agreement By-law, 2000, No. 14203."  
.....

The Council of the City of Surrey, in open meeting assembled, ENACTS AS FOLLOWS:

1. The City is authorized to enter into an amendment to the heritage revitalization agreement authorized by "Surrey Heritage Revitalization Agreement By-law, 2000, No. 14203" regarding certain lands and premises located within the City of Surrey and more particularly known and described as:

Parcel Identifier: 025-635-794  
 Lot 2 District Lot 157 Group 2 New Westminster District Plan BCP4864  
 13951 Crescent Road

(The "Heritage Revitalization Agreement").

2. The terms and conditions of the amending agreement (the "Amending Agreement") are attached to and form part of this By-law as Schedule "1", and the Amending Agreement becomes an addition to the Heritage Revitalization Agreement.
3. The Mayor and Clerk are authorized on behalf of the City to sign the Amending Agreement and to do all acts necessary and incidental to the completion of the Amending Agreement.
4. This By-law shall be cited for all purposes as "City of Surrey Heritage Revitalization Agreement By-law, 2000, No. 14203, Amendment By-law, 2012, No. \_\_\_\_\_".

PASSED FIRST AND SECOND READINGS on the \_\_\_\_\_ day of \_\_\_\_\_, 2012.

PUBLIC HEARING HELD thereon on the \_\_\_\_\_ day of \_\_\_\_\_, 2012.

PASSED THIRD READING on the \_\_\_\_\_ day of \_\_\_\_\_, 2012.

RECONSIDERED AND FINALLY ADOPTED, signed by the Mayor and Clerk, and sealed with the Corporate Seal on the \_\_\_\_\_ day of \_\_\_\_\_, 2012.

\_\_\_\_\_MAYOR

\_\_\_\_\_CLERK



**SCHEDULE 1**

**SURREY HERITAGE REVITALIZATION AGREEMENT  
DANIEL JOHNSON HOUSE  
AMENDING AGREEMENT**

**THIS AGREEMENT** dated for reference the \_\_\_\_ day of \_\_\_\_\_, 2012.

**BETWEEN:**

**CITY OF SURREY**  
14245 - 56th Avenue  
Surrey, B.C., V3X 3A2

(the "City")

**OF THE FIRST PART**

**AND:**

**MARC STEPHEN HIATT**  
**MARY-ANNE HIATT**  
13951 Crescent Road  
Surrey, B.C. V4P 1J4

(the "Owner")

**OF THE SECOND PART**

**WHEREAS:**

- A. The City of and the City of Surrey, Realty Section, Engineering Department (the "Previous Owner") entered into a Heritage Revitalization Agreement dated for reference March 24, 2003 (the "Agreement") for the conservation, restoration, maintenance, and protection of the Lands, including the Daniel Johnson House, as more particularly described in the Agreement;
- B. Each capitalized term not otherwise defined herein shall have the meaning ascribed to it in the Agreement;
- C. The Previous Owner has transferred the Lands to the Owner, who is bound by the terms and conditions of the Agreement by operation of the Agreement and the *Local Government Act*;
- D. The City and the Owner wish to amend the terms of the Agreement to allow for the construction of a replica of the Daniel Johnson House, the construction of an addition to the replicated Daniel Johnson House, the construction of a detached garage with *accessory dwelling unit* located within the garage, and the construction of an accessory building (pool house) on the property.

**NOW THEREFORE** this Amending Agreement witnesses that in consideration of the sum of \$1.00 paid by each party to the other and other good and valuable consideration (the receipt and sufficiency of which each party hereby acknowledges), the parties hereby covenant and agree as follows:

## 1. Amendments

The Agreement is hereby amended as follows:

- 1.1. Under the recital, "WHEREAS", Section A., by deleting the reference to the legal description and civic address of the Lands and replacing it with the following:

Parcel Identifier: 025-635-794  
Lot 2 District Lot 157 Group 2 New Westminster District Plan BCP4864  
13951 Crescent Road

- 1.2. In Section 2 of the Agreement, by adding the following words to the end of Subsection (d):

except as provided for in Subsection 2(d.1);

- 1.3. In Section 2 of the Agreement, by inserting the following new Subsection (d.1) after Subsection (d):

(d.1) despite Subsection (d) of this Section 2 and Subsection II of Schedule "B", the Johnson House may encroach 8.5 metres [28 feet] into the rear yard setback applicable to the Lands;

- 1.4. In Section 3 of the Agreement, by deleting the word "and" from Subsection (b) and replacing the period at the end of Subsection (c) with a semicolon.

- 1.5. In Section 3 of the Agreement, by inserting the following new Subsections (d) and (e) after Subsection (c):

(d) Section G of Part 12, One-Acre Residential Zone (RA) of City of Surrey Zoning By-law, 1993, No. 12000, as amended, is hereby amended as set out in Section III of Schedule "B" which is incorporated hereto and forms part of this Agreement as it relates to the Lands; and

(e) Section B of Part 12, One-Acre Residential Zone (RA) of City of Surrey Zoning By-law, 1993, No. 12000, as amended, is hereby amended as set out in Section I of Schedule "B" which is incorporated hereto and forms part of this Agreement as it relates to the Lands.

- 1.6. In Section 14 of the Agreement, by deleting the references to the Owner's name and mailing address and replacing them with the following:

**MARC STEPHEN HIATT**  
**MARY-ANNE HIATT**  
13951 Crescent Road  
Surrey, B.C. V4P 1J4

- 1.7. In Schedule "A" of the Agreement under "Part II - Standards and Specifications of Restoration and New Construction", Section 3, "New Garage and Accessory Building", by deleting the words "one-car or two-car" wherever they occur.

- 1.8. In Schedule "A" of the Agreement under "Part III - Continued Maintenance, Protection and Future Construction", Section 1, "General", by deleting the following paragraph:

The construction or alteration of any improvements on the Lands so as to create a secondary suite or suite of any kind whether for use by the owner or otherwise shall not be permitted.

- 1.9. In Schedule "A" of the Agreement under "Part III - Continued Maintenance, Protection and Future Construction", Section 6, "Landscaping", by deleting the first paragraph and replacing it with the following paragraph:

Landscaping is preferred as an alternative to typical perimeter fencing. Indigenous plant materials are recommended to augment the historical character of Crescent Road. The area of the Lands outside the Restricted Building Envelope shall be retained in its landscaped and cultivated state except as provided for in Section 2 (d.1) of the Agreement.

- 1.10. In Schedule "B" of the Agreement, by deleting Section I. and replacing it with the following new Section I.:

**I. Section D, Density, is replaced with the following:**

"For *building* construction within a *lot*, the *floor area ratio* shall not exceed 0.10, provided that, of the resulting allowable floor area, a maximum of:

- 444 sq. m. [4769 sq.ft.] shall be reserved for the *principal building* (305.5 sq. m. [3,288 sq.ft.] shall be for the original Daniel Johnson House and 138 sq. m. [1,481 sq. ft.] shall be for an addition to the Daniel Johnson House),
- 110 sq. m. [1,184 sq. ft.] shall be reserved for use only as a garage to be detached from the *principal building*,
- 58 sq. m. [623 sq. ft.] shall be reserved for use only as an *accessory dwelling unit* located within the garage, and
- 56 sq. m. [600 sq. ft.] shall be reserved for use only as an *accessory building*.

The floor area of any *accessory building* or *structure* that is equal to or less than 10 square metres [105 sq.ft.] shall not be included as part of the floor area for the purpose of calculating *floor area ratio*."

- 1.11. In Schedule "B" of the Agreement, by inserting the following new Subsections IV and V after Subsection III:

**IV. Section G, Height of Buildings, Subsection 1 and 2 are replaced with the following:**

1. *Principal building*: The height shall not exceed 12.53 metres [41.11 ft].
2. *Accessory buildings and structures*: The height shall not exceed 4 metres [13 ft.] except that where the roof slope and construction materials of an *accessory building* are the same as that of the *principal building*, the *building height* of the *accessory building* may

be increased to 5 metres [16.5 ft.] or where an *accessory dwelling unit* is located above an *accessory building*, the *building height* of an *accessory building* may be increased to 6 metres [19.75 ft.].

**V. Section B, Permitted Uses, Subsection 1 is replaced with the following:**

1. One *single family dwelling* and one *accessory dwelling unit* provided that the *accessory dwelling unit* is located within the garage.

**2. Due Execution**

The Owner hereby represents and warrants to the City that this Amending Agreement has been duly authorized and executed by the Owner and that the delivery of this Amending Agreement has been duly authorized by all necessary corporate action on the part of the Owner.

**3. Full Force and Effect**

The City and the Owner hereby agree that the Agreement shall hereinafter be read and construed in conjunction with this Amending Agreement and be regarded as being amended only to the extent herein provided, that all the terms, covenants, provisos, conditions and provisions of the Agreement, as amended hereby, shall continue to be in full force and effect and that nothing herein contained shall operate or be construed to modify or otherwise affect the rights and obligations created by the Agreement as amended hereby.

**4. Enurement**

This Agreement shall enure to the benefit of and be binding upon the respective successors and permitted assigns of the City and the Owner.

**5. Notice to be Filed**

Notice of this Agreement will be filed in the Land Title Office and once filed, this Agreement will be binding on all persons who acquire an interest in the Lands.

**IN WITNESS WHEREOF** the parties have executed this Amending Agreement as of the date set out above.

**CITY OF SURREY**

by its authorized signatories

---

Dianne Watts  
Mayor

---

Jane Sullivan  
City Clerk

**MARC STEPHEN HIATT**  
**MARY-ANNE HIATT**

---

Marc Stephen Hiatt

---

Mary-Anne Hiatt

v:\wp-docs\admin & policy\12data\apr-june\06191109es.doc  
. 7/5/12 2:57 PM

Proposed Plans

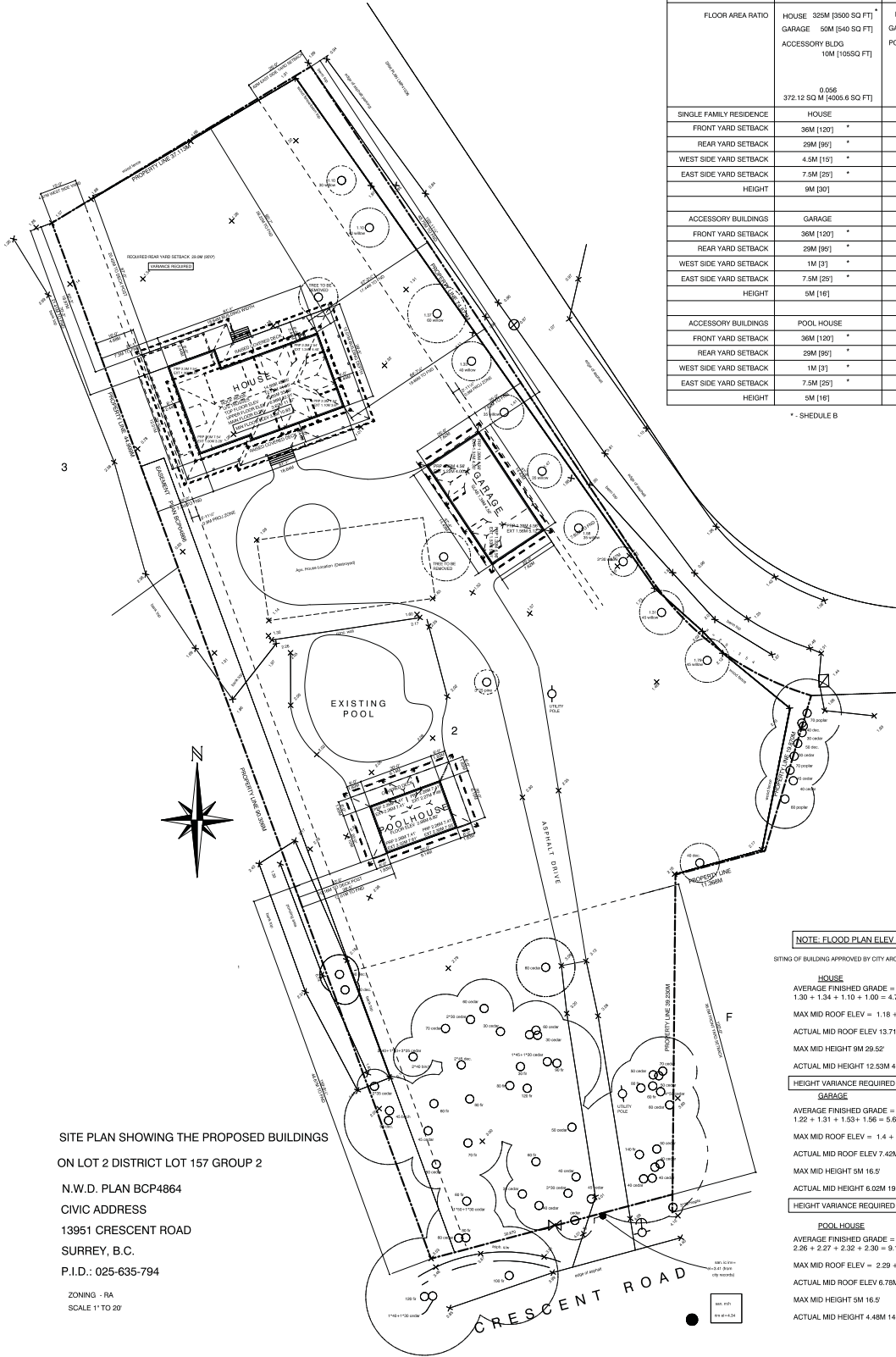

SITE PLAN SHOWING THE PROPOSED BUILDINGS  
 ON LOT 2 DISTRICT LOT 157 GROUP 2  
 N.W.D. PLAN BCP4864  
 CIVIC ADDRESS  
 13951 CRESCENT ROAD  
 SURREY, B.C.  
 P.I.D.: 025-635-794  
 ZONING - RA  
 SCALE 1" TO 20'

| BYLAW ITEM              | BYLAW ITEM  | ACTUAL  | VARIANCE                   |
|-------------------------|---|---|----------------------------|
| COVERAGE                | 20% 14305.7 SQ FT   | 8.6%<br>HOUSE (INCL DECKS) = 362.69 SQ M (3904 SQ FT)<br>GARAGE = 109.9 SQ M (1183.3 SQ FT)<br>POOL HOUSE = 101.45 SQ M (1092 SQ FT)<br>TOTAL = 574 SQ M [6169 SQ FT] OR 8.6%   |                            |
| FLOOR AREA RATIO        | HOUSE 325M (3500 SQ FT)<br>GARAGE 50M (540 SQ FT)<br>ACCESSORY BLDG 10M (105SQ FT)<br>0.095<br>372.12 SQ M (4005.6 SQ FT) | HOUSE 443.04 SQ M (4769 SQ FT)<br>GARAGE 167.81 SQ M (1806.3 SQ FT)<br>POOL HOUSE 55.74 SQ M (600 SQ FT)<br>TOTAL 666.61 SQ M (7175.3 SQ FT)<br>LESS 19 SQ M (105 SQ FT)<br>BUILDING ALLOWANCE = 656.85 SQ M (7070.3 SQ FT) = 0.9888 F.S.R. | 254.74 SQ M (3064.9 SQ FT) |
| SINGLE FAMILY RESIDENCE | HOUSE   |   |                            |
| FRONT YARD SETBACK      | 36M (120) *   | 102.7M (337)  |                            |
| REAR YARD SETBACK       | 29M (95) *  | 20.42M (67)   | 8.53M (28)                 |
| WEST SIDE YARD SETBACK  | 4.5M (15) *   | 4.88M (16)  |                            |
| EAST SIDE YARD SETBACK  | 7.5M (25) *   | 17.44M (57.23)  |                            |
| HEIGHT                  | 9M (30)   | 12.53M (41.10)  | 3.53M (11.58)              |
| ACCESSORY BUILDINGS     | GARAGE  |   |                            |
| FRONT YARD SETBACK      | 36M (120) *   | 48.75M (159.93)   |                            |
| REAR YARD SETBACK       | 29M (95) *  | 30.2M (99.3)  |                            |
| WEST SIDE YARD SETBACK  | 1M (3) *  | 33.22M (109)  |                            |
| EAST SIDE YARD SETBACK  | 7.5M (25) *   | 7.5M (25)   |                            |
| HEIGHT                  | 5M (16)   | 6.02M (19.74)   | 1.02M (3.35)               |
| ACCESSORY BUILDINGS     | POOL HOUSE  |   |                            |
| FRONT YARD SETBACK      | 36M (120) *   | 48.67M (159.69)   |                            |
| REAR YARD SETBACK       | 29M (95) *  | 62.90M (207.2)  |                            |
| WEST SIDE YARD SETBACK  | 1M (3) *  | 10.16M (33.42)  |                            |
| EAST SIDE YARD SETBACK  | 7.5M (25) *   | 27.15M (89)   |                            |
| HEIGHT                  | 5M (16)   | 4.48M (14.70)   |                            |

NOTE: FLOOD PLAN ELEV 3.30M

SITING OF BUILDING APPROVED BY CITY ARCHITECT APRIL 2012

**HOUSE**  
 AVERAGE FINISHED GRADE =  
 $1.30 + 1.34 + 1.10 + 1.00 = 4.74/4 = 1.18M\ 3.89'$   
 MAX MID ROOF ELEV =  $1.18 + 9 = 10.18M\ 33.40'$   
 ACTUAL MID ROOF ELEV 13.71M 44.97'  
 MAX MID HEIGHT 9M 29.52'  
 ACTUAL MID HEIGHT 12.53M 41.10'

HEIGHT VARIANCE REQUIRED

**GARAGE**  
 AVERAGE FINISHED GRADE =  
 $1.22 + 1.31 + 1.53 + 1.56 = 5.62/4 = 1.4M\ 4.6'$   
 MAX MID ROOF ELEV =  $1.4 + 5 = 6.4M\ 21.0'$   
 ACTUAL MID ROOF ELEV 7.42M 24.35'  
 MAX MID HEIGHT 5M 16.5'  
 ACTUAL MID HEIGHT 6.02M 19.74'

HEIGHT VARIANCE REQUIRED

**POOL HOUSE**  
 AVERAGE FINISHED GRADE =  
 $2.26 + 2.27 + 2.32 + 2.30 = 9.15M/4 = 2.29M\ 7.51'$   
 MAX MID ROOF ELEV =  $2.29 + 5 = 7.29M\ 23.92'$   
 ACTUAL MID ROOF ELEV 6.78M 22.6'  
 MAX MID HEIGHT 5M 16.5'  
 ACTUAL MID HEIGHT 4.48M 14.7'

These drawings remain the property of Rusbourne Design Ltd and may not be reproduced without written consent from same.

THESE DRAWINGS CONFORM TO THE BC B.C. 2006 EDITION

REVISIONS

**RUSBOURNE DESIGN LTD**  
 2225 HARTLEY AVENUE,  
 COQUITLAM, B.C. V3K 6W9  
 TEL: 604 526 7444  
 email: info@rusbourndesigns.com

PROJECT  
 13951 CRESCENT RD  
 SURREY, B.C.

SHEET TITLE  
 MAIN FLOOR

DATE May 18, 2012  
 DRAWN S.G.  
 CHECKED B.R.

SCALE 1/4" = 10'  
 PLAN NUMBER  
 TS-5B-4769

SHEET NUMBER  
 A2

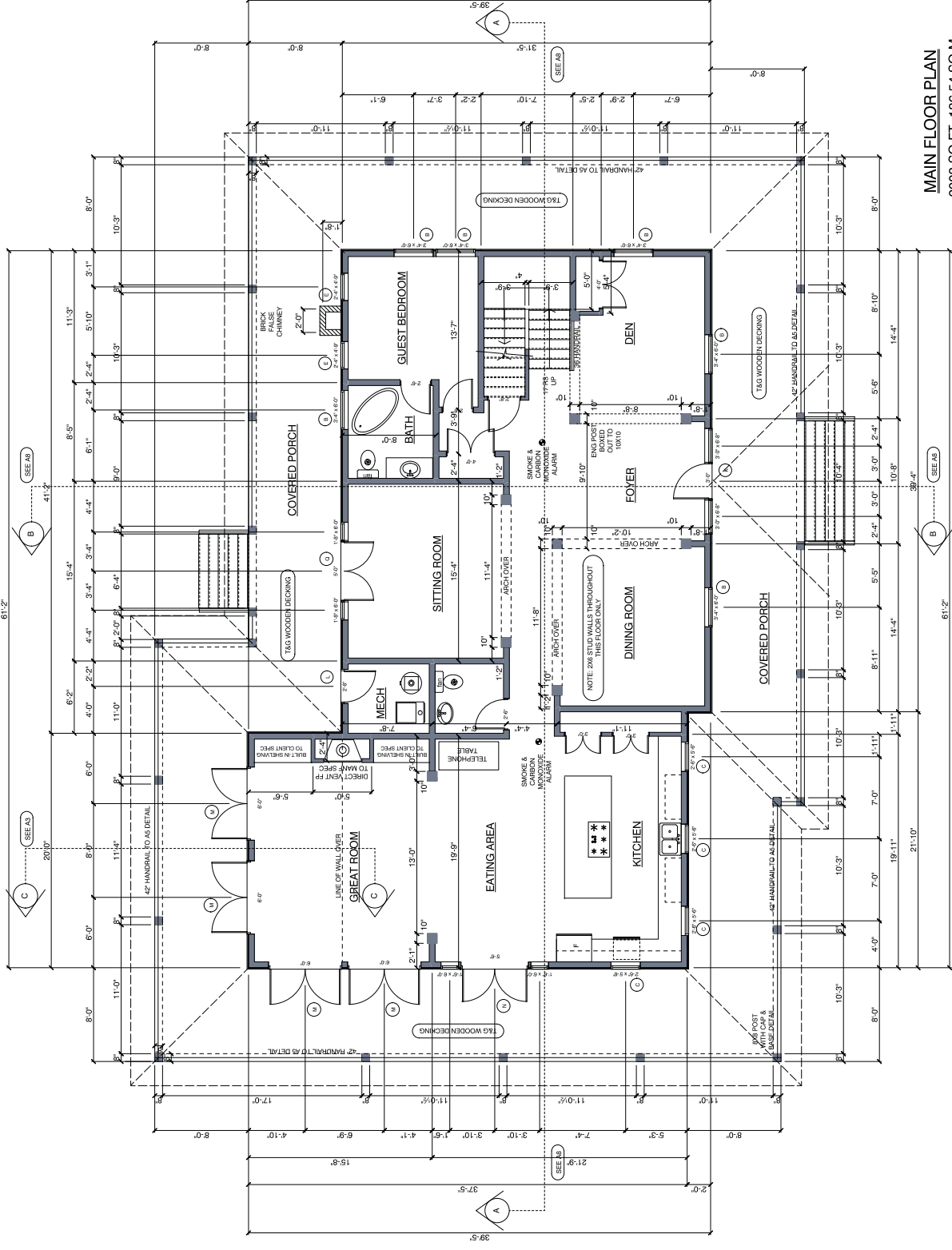

MAIN FLOOR PLAN  
 2008 SQ.FT. 186.54 SQ M

These drawings remain the property of Rusbourne Design Ltd and may not be reproduced without written consent from same.

THESE DRAWINGS CONFORM TO THE BC B.C. 2006 EDITION

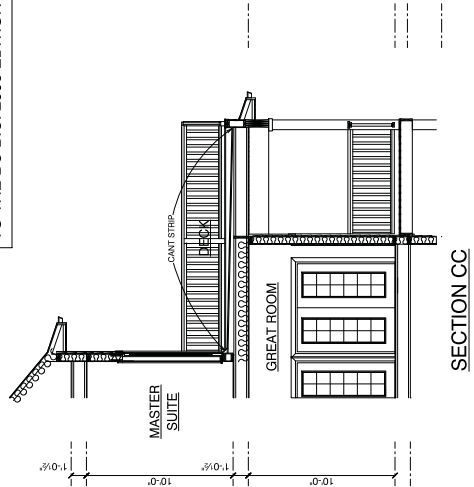
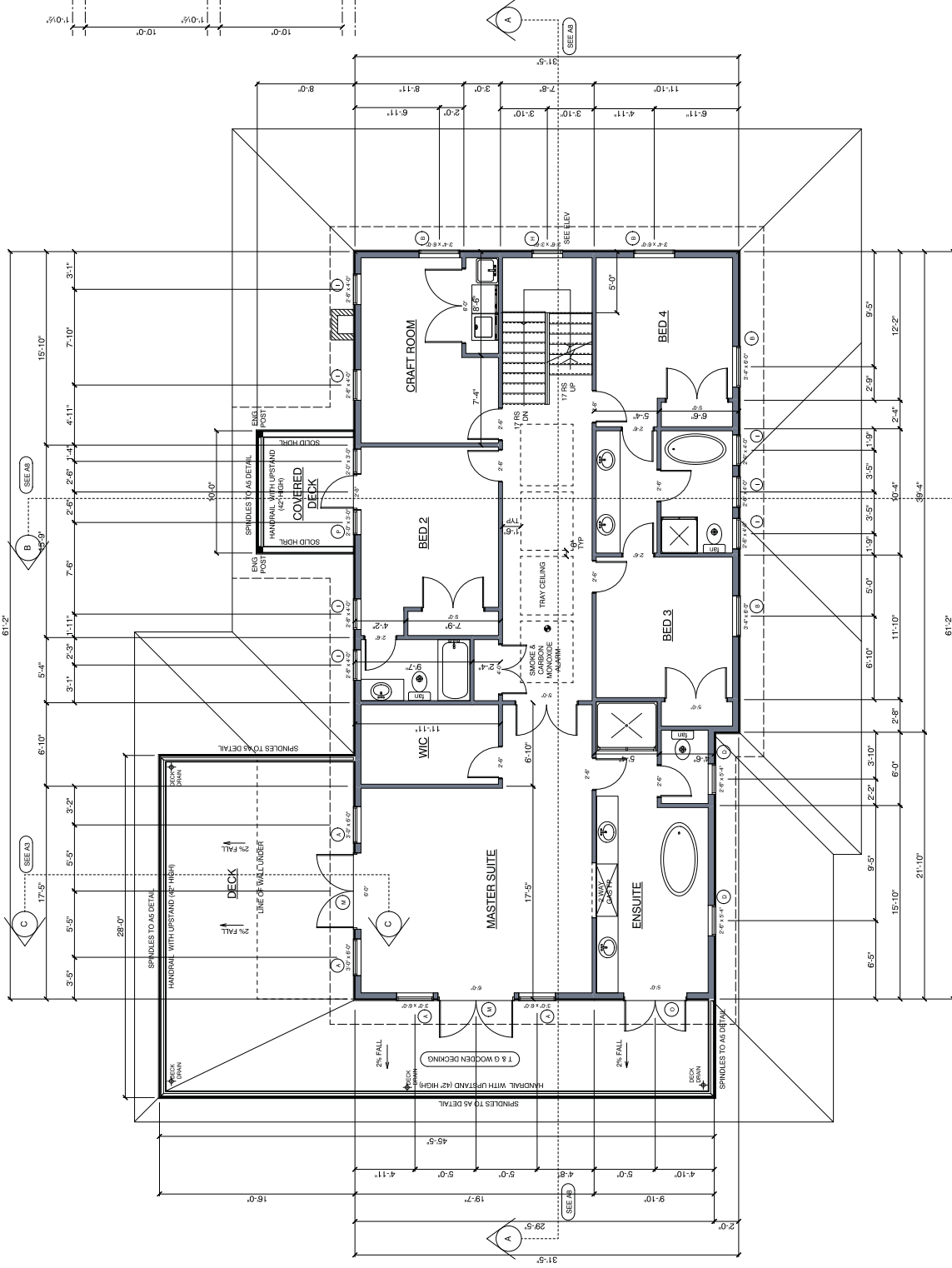

REVISIONS

**RUSBOURNE DESIGN LTD**  
 2225 HARTLEY AVENUE,  
 COQUITLAM, B.C. V3K 6W9  
 TEL: 604 526 7444  
 email: info@rusbourndesigns.com

PROJECT  
 19951 CRESCENT RD  
 SURREY, B.C.

SHEET TITLE

UPPER FLOOR

DATE May 18, 2012

DRAWN S.G.

CHECKED B.R.

SCALE: 1/4" = 10'

PLAN NUMBER  
 TS-5B-4769

SHEET NUMBER  
 A3

UPPER FLOOR PLAN  
 1880 SQ.FT. 174.65 SQ M



These drawings remain the property of Rusbourne Design Ltd and may not be reproduced without written consent from same.

**THESE DRAWINGS CONFORM TO THE BC B.C. 2006 EDITION**

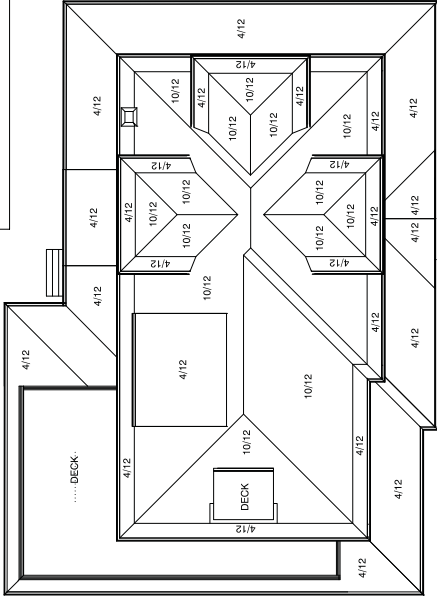

**ROOF PLAN**

**REVISIONS**

**RUSBOURNE DESIGN LTD**  
 2225 HARTLEY AVENUE,  
 COQUITLAM, B.C. V3K 6W9  
 TEL: 604.526.7444  
 email: info@rusbournedesigns.com

**PROJECT**  
 13951 CRESCENT RD  
 SURREY, B.C.

**SHEET TITLE**  
 TOP FLOOR

**DATE** May 18, 2012  
**DRAWN** S.G.  
**CHECKED** B.R.  
**SCALE** 1/4" = 10'

**PLAN NUMBER**  
 TS-5B-4769  
**SHEET NUMBER**  
 A4

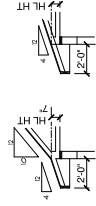

**EAVE DETAILS**

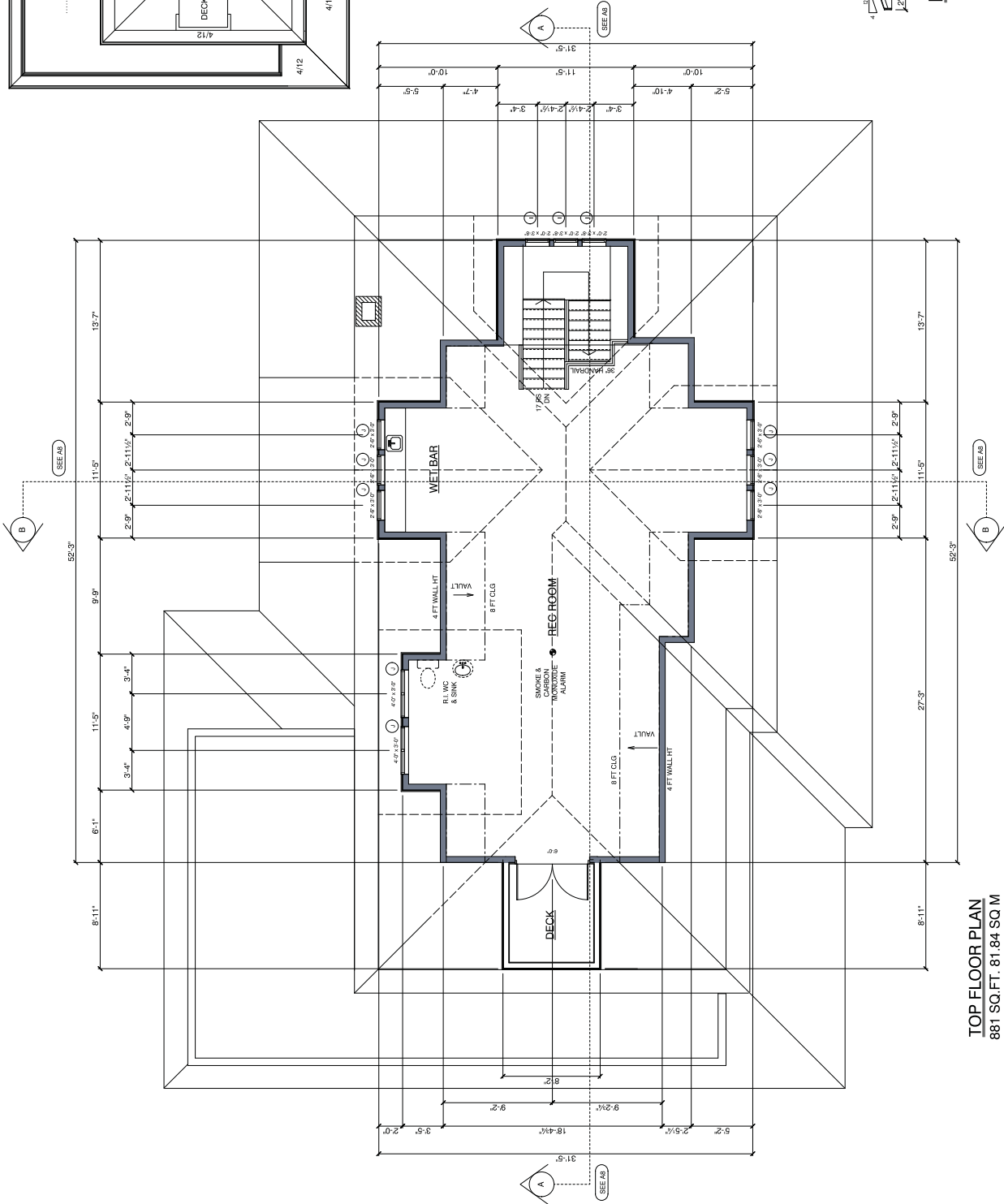

**TOP FLOOR PLAN**  
 881 SQ.FT. 81.84 SQ M

These drawings remain the property of Rusbourne Design Ltd and may not be reproduced without written consent from same.

THESE DRAWINGS CONFORM TO THE BC B.C. 2006 EDITION

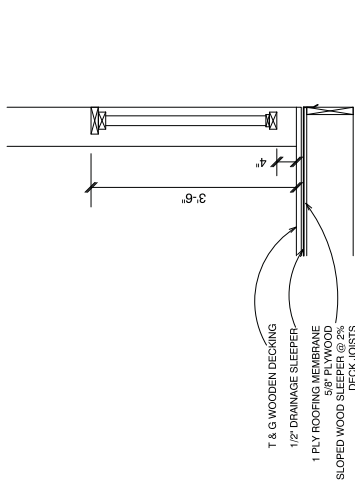

LOWER DECK & HANDRAIL DETAIL

**COLOUR SCHEME**

|                      |                      |               |
|----------------------|----------------------|---------------|
| Wood siding          | Saybrook Sage HC114  | Semi-Gloss Ac |
| Wood Shingles        | Catwalk green HC 124 |               |
| Window Sash          | Glaze Black VC 35    |               |
| Window and door Trim | Whitman Cream HC 6   |               |
| Stairs (Bases)       | Harris Grey VC 25    |               |
| Gutters downspouts   | Glaze Black VC 35    |               |
| Cedar roof Shingles  | Bare                 |               |
| Exterior Doors       | HC 157               |               |
| Trim & Soffit        | HC 6                 |               |

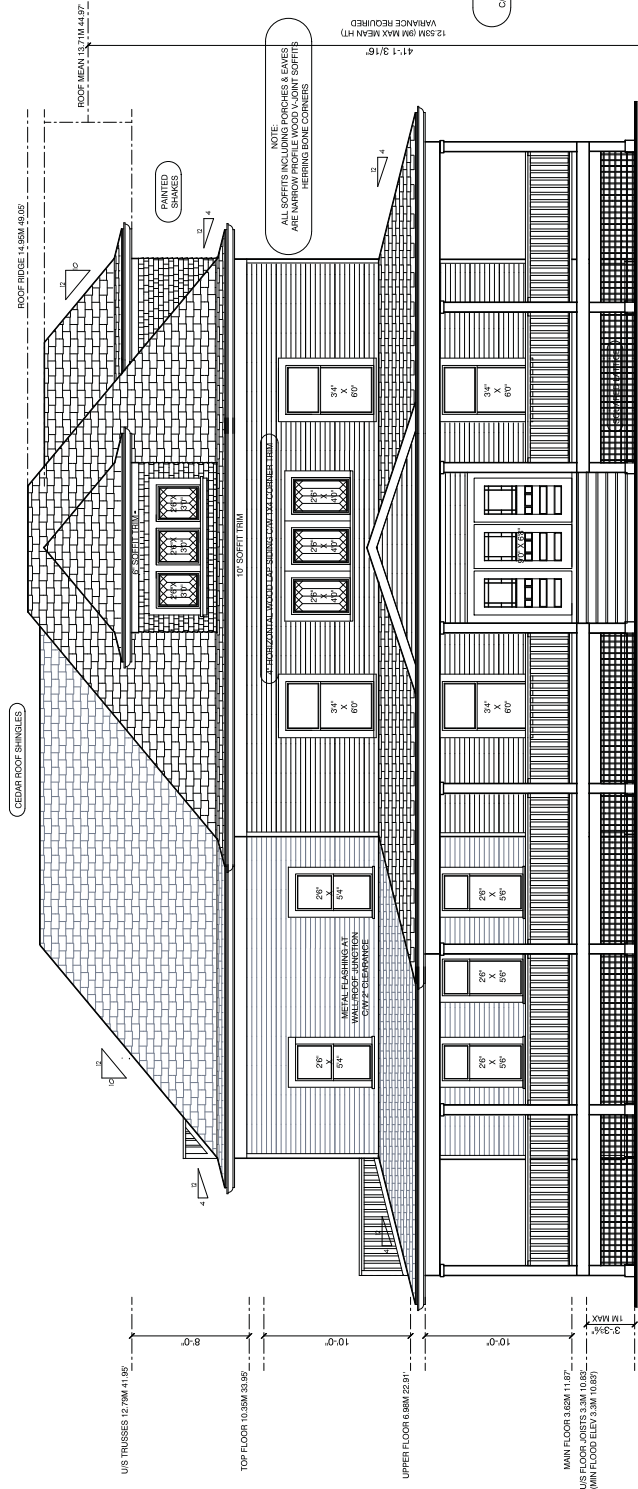

SOUTH ELEVATION

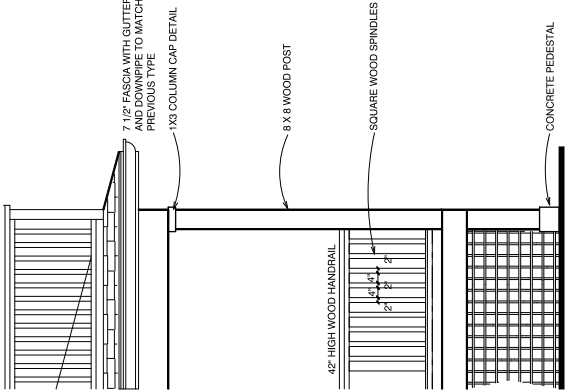

DETAILS

REVISIONS

**RUSBOURNE DESIGN LTD**  
 2225 HARTLEY AVENUE,  
 COQUITLAM, B.C. V3K 6W9  
 TEL: 604 526 7444  
 email: info@rusbourne-designs.com

PROJECT  
 13951 CRESCENT RD  
 SURREY, B.C.

SHEET TITLE  
**SOUTH ELEVATION**

DATE: June 12, 2012  
 DRAWN: S.G.  
 CHECKED: B.R.

SCALE: 1/4" = 1'-0"  
 PLAN NUMBER  
 TS-5B-4769

SHEET NUMBER  
 A5

DOUBLE GLAZED WOOD FRAMED  
 CW 6" WOOD TRIM BOARDS & 2" SILLS

NOTE  
 ALL SOFFITS INCLUDE FINISHES & SINGS  
 ARE NARROW PROFILE WOOD JOINT SOFFITS  
 HERRING BONE CORNERS

12.53M (RM MAX MEAN HT)  
 VARIANCE REQUIRED  
 41'-1.3/16"

ALSO IN SCALE  
 1:18M 3.57"

PRP 2.3M 7.54'  
 EXT 1.18M 3.87'

PRP 2.3M 7.54'  
 EXT 1.00M 3.28'

US TRUSSES 12.28M 41.95'  
 TOP FLOOR 10.35M 33.95'  
 UPPER FLOOR 6.98M 22.91'  
 MAIN FLOOR 3.62M 11.87'  
 US FLOOR JOISTS 3.3M 10.83'  
 (MIN FLOOR ELEV 3.3M 10.83')

These drawings remain the property of Rusbourne Design Ltd and may not be reproduced without written consent from same.

THESE DRAWINGS CONFORM TO THE BC B.C. 2006 EDITION

**COLOR SCHEME**

- Wood siding Skywood, Sage HC114 Semi Gloss Ac
- Wood Shingles Catalina Green HC 124
- Window Sash Glass Black VC 35
- Window and door Trim Waintham Cream HC 6
- Stairs (Skops) Harlequin VC 25
- Gutters downspouts Glass Black VC 35
- Cedar roof Shingles Bare
- Exterior Doors HC 157
- Trim & Soffit HC 6

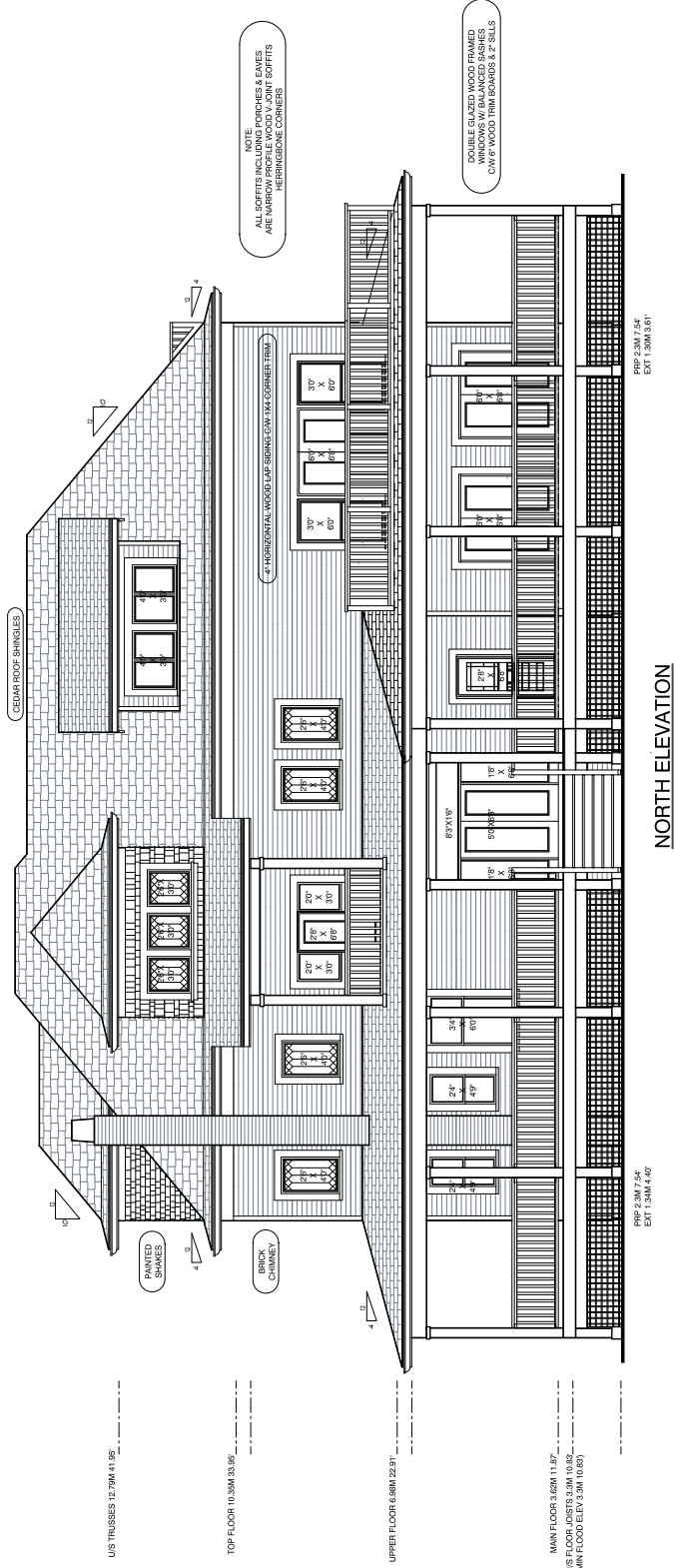

US TRUSSES 12.79M 41.95'

TOP FLOOR 10.35M 33.95'

UPPER FLOOR 6.98M 22.91'

MIN FLOOR 3.62M 11.87'

US FLOOR JOISTS 3.2M 10.82'  
(MIN FLOOR ELEV 3.3M 10.85')

PRP 2.3M 7.54'  
EXT 1.34M 4.40'

PRP 2.3M 7.54'  
EXT 1.30M 3.94'

NORTH ELEVATION

**REVISIONS**

**RUSBOURNE DESIGN LTD**  
 2225 HARTLEY AVENUE,  
 COQUITLAM, B.C. V3K 6W9  
 TEL: 604.526.7444  
 email: info@rusbourndesigns.com

**PROJECT**

13951 CRESCENT RD  
 SURREY, B.C.

**SHEET TITLE**

NORTH ELEVATION

DATE: June 12, 2012

DRAWN: S.G.

CHECKED: B.R.

SCALE: 1/4" = 1'

PLAN NUMBER

TS-5B-4769

SHEET NUMBER

A6

These drawings remain the property of Rusbourne Design Ltd and may not be reproduced without written consent from same.

THESE DRAWINGS CONFORM TO THE BC B.C. 2006 EDITION

REVISIONS

**RUSBOURNE DESIGN LTD**  
 2225 HARTLEY AVENUE,  
 COQUITLAM, B.C. V3K 6W9  
 TEL. 604.526.7444  
 email: info@rusbourndesigns.com

PROJECT

13951 CRESCENT RD  
 SURREY, B.C.

SHEET TITLE

EAST & WEST ELEVATIONS

DATE: June 12, 2012

DRAWN: S.G.

CHECKED: B.R.

SCALE: 1/4" = 10'

PLAN NUMBER

TS-5B-4769

SHEET NUMBER

A7

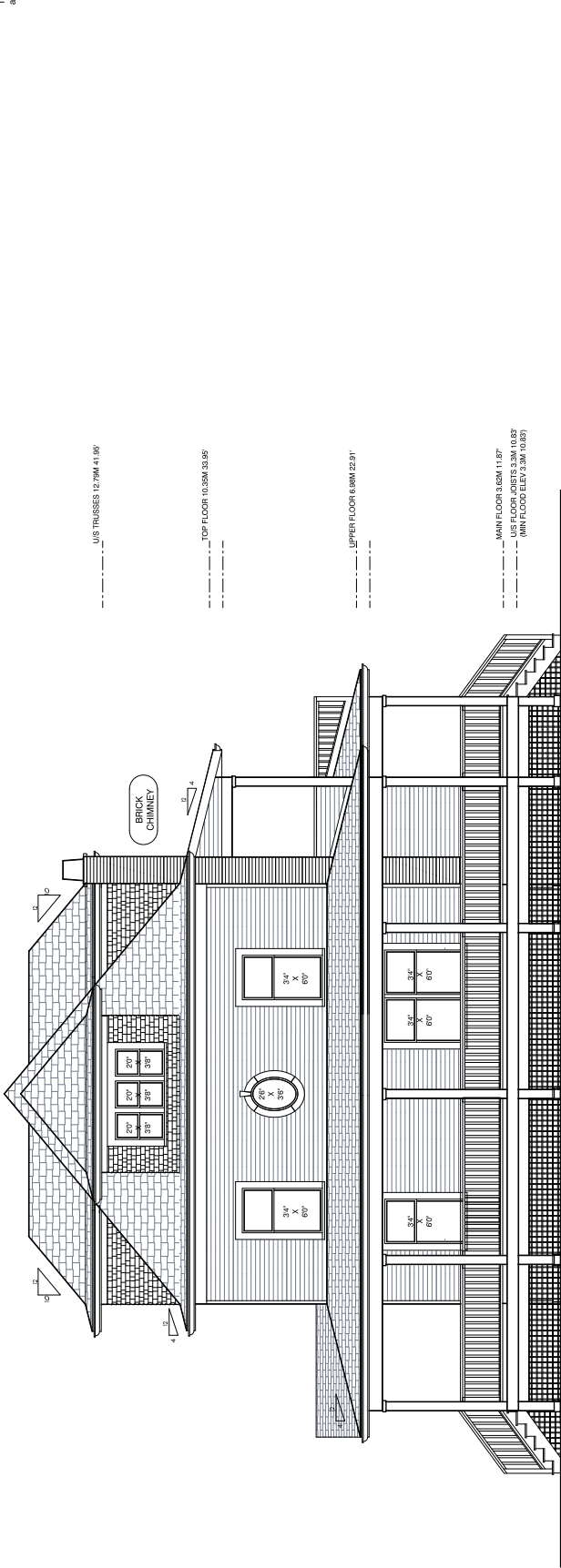

EAST ELEVATION

PRP 2.3M 7.54'  
 EXT 1.5M 4.92'

PRP 2.3M 7.54'  
 EXT 1.5M 4.92'

PRP 2.3M 7.54'  
 EXT 1.5M 4.92'

PRP 2.3M 7.54'  
 EXT 1.5M 4.92'

US TRUSSES 12.79M 41.95'

TOP FLOOR 10.33M 33.95'

UPPER FLOOR 6.98M 22.91'

MAIN FLOOR 3.62M 11.87'

US FLOOR JOISTS 3.3M 10.85'  
 (MIN FLOOR ELEV. 3.3M 10.85')

US TRUSSES 12.79M 41.95'

TOP FLOOR 10.33M 33.95'

UPPER FLOOR 6.98M 22.91'

MAIN FLOOR 3.62M 11.87'

US FLOOR JOISTS 3.3M 10.85'  
 (MIN FLOOR ELEV. 3.3M 10.85')

**COLOUR SCHEME**

|                      |                |        |               |
|----------------------|----------------|--------|---------------|
| Wood siding          | Sagecroft Sage | HC14   | Semi Glass Ac |
| Wood Shingles        | Catwell green  | HC 124 |               |
| Window Sash          | Gloss Black    | VC 35  |               |
| Window and door Trim | Whitman Cream  | HC 6   |               |
| Stairs (Steps)       | Hains Grey     | VC 25  |               |
| Gutter/ downspouts   | Gloss Black    | VC 35  |               |
| Cedar roof Shingles  | Blau           |        |               |
| Exterior Doors       | HC 157         |        |               |
| Trim & Soffit        | HC 6           |        |               |

WEST ELEVATION

PRP 2.3M 7.54'  
 EXT 1.5M 4.92'

PRP 2.3M 7.54'  
 EXT 1.5M 4.92'

PRP 2.3M 7.54'  
 EXT 1.5M 4.92'

PRP 2.3M 7.54'  
 EXT 1.5M 4.92'

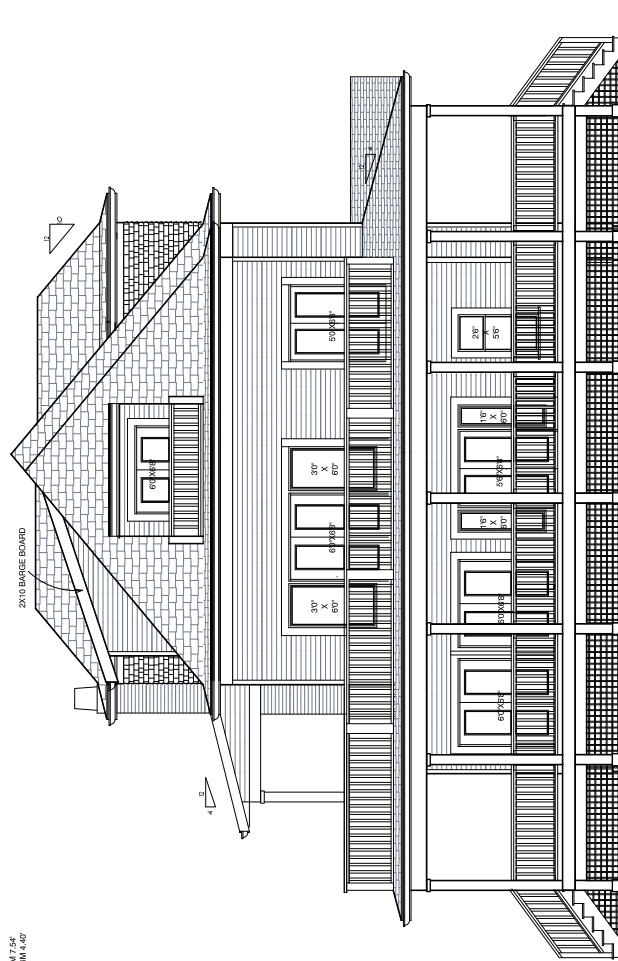

These drawings remain the property of Rusbourne Design Ltd and may not be reproduced without written consent from same.

THESE DRAWINGS CONFORM TO THE BC B.C. 2006 EDITION

US TRUSSES 12'20" x 41'80"

TOP FLOOR 10.35M 33.95'

UPPER FLOOR 6.88M 22.91'

MAIN FLOOR 3.15M 11.87'

US FLOOR JOISTS 3.3M 10.83'

(MIN FLOOR ELEV 3.3M 10.83')

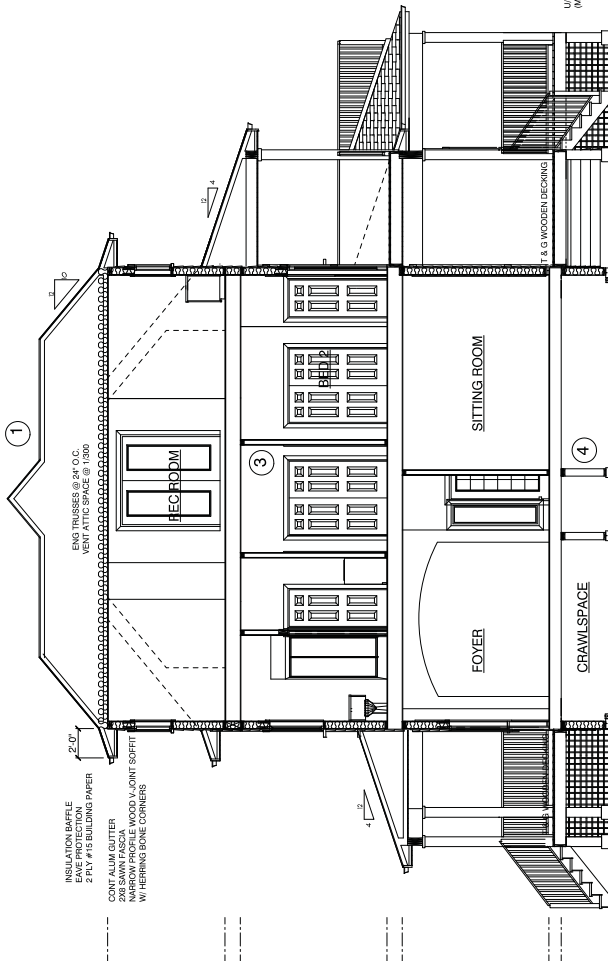

INSULATION BATTLE  
2 PLY 415 BUILDING PAPER  
2 PLY 415 BUILDING PAPER  
2X8 SWAIN PASCIA  
W/ 1/2" GIBBS  
W/ 1/2" GIBBS

4" X 4" ALUM GUTTER

2X8 SWAIN PASCIA

W/ 1/2" GIBBS

W/ 1/2" GIBBS

W/ 1/2" GIBBS

W/ 1/2" GIBBS

W/ 1/2" GIBBS

W/ 1/2" GIBBS

W/ 1/2" GIBBS

W/ 1/2" GIBBS

W/ 1/2" GIBBS

W/ 1/2" GIBBS

W/ 1/2" GIBBS

W/ 1/2" GIBBS

W/ 1/2" GIBBS

W/ 1/2" GIBBS

W/ 1/2" GIBBS

W/ 1/2" GIBBS

W/ 1/2" GIBBS

W/ 1/2" GIBBS

W/ 1/2" GIBBS

W/ 1/2" GIBBS

W/ 1/2" GIBBS

W/ 1/2" GIBBS

W/ 1/2" GIBBS

W/ 1/2" GIBBS

W/ 1/2" GIBBS

W/ 1/2" GIBBS

W/ 1/2" GIBBS

W/ 1/2" GIBBS

W/ 1/2" GIBBS

W/ 1/2" GIBBS

W/ 1/2" GIBBS

W/ 1/2" GIBBS

W/ 1/2" GIBBS

W/ 1/2" GIBBS

W/ 1/2" GIBBS

W/ 1/2" GIBBS

W/ 1/2" GIBBS

W/ 1/2" GIBBS

W/ 1/2" GIBBS

W/ 1/2" GIBBS

W/ 1/2" GIBBS

W/ 1/2" GIBBS

W/ 1/2" GIBBS

W/ 1/2" GIBBS

W/ 1/2" GIBBS

W/ 1/2" GIBBS

W/ 1/2" GIBBS

W/ 1/2" GIBBS

W/ 1/2" GIBBS

W/ 1/2" GIBBS

W/ 1/2" GIBBS

W/ 1/2" GIBBS

W/ 1/2" GIBBS

W/ 1/2" GIBBS

W/ 1/2" GIBBS

W/ 1/2" GIBBS

W/ 1/2" GIBBS

W/ 1/2" GIBBS

W/ 1/2" GIBBS

W/ 1/2" GIBBS

W/ 1/2" GIBBS

W/ 1/2" GIBBS

W/ 1/2" GIBBS

W/ 1/2" GIBBS

W/ 1/2" GIBBS

W/ 1/2" GIBBS

W/ 1/2" GIBBS

W/ 1/2" GIBBS

W/ 1/2" GIBBS

W/ 1/2" GIBBS

W/ 1/2" GIBBS

W/ 1/2" GIBBS

W/ 1/2" GIBBS

W/ 1/2" GIBBS

W/ 1/2" GIBBS

W/ 1/2" GIBBS

W/ 1/2" GIBBS

WINDOW/DOOR SCHEDULE

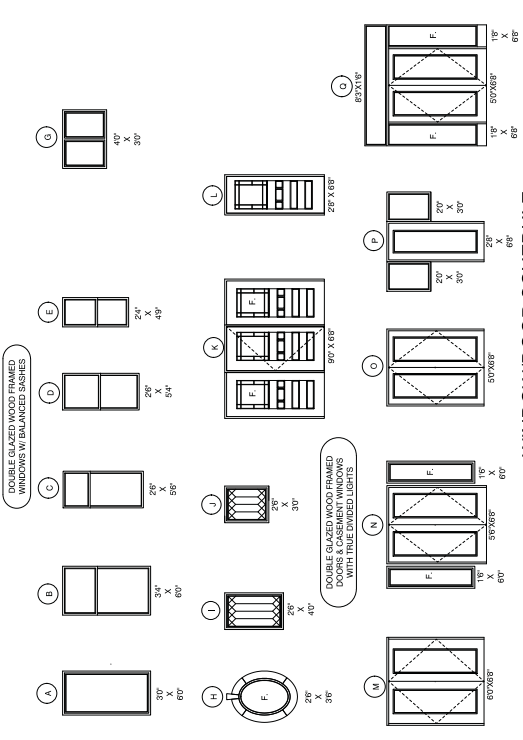

REVISIONS

**RUSBOURNE DESIGN LTD**  
2225 HARTLEY AVENUE,  
COQUITLAM, B.C. V3K 6W9  
TEL: 604 526 7444  
email: info@rusbournedesigns.com

PROJECT  
13951 CRESCENT RD  
SURREY, B.C.

SHEET TITLE  
SECTIONS & WINDOW  
SCHEDULE

DATE May 18, 2012  
DRAWN S.G.  
CHECKED B.R.

SCALE: 1/4" = 1'0"

PLAN NUMBER  
TS-5B-4769

SHEET NUMBER  
A8

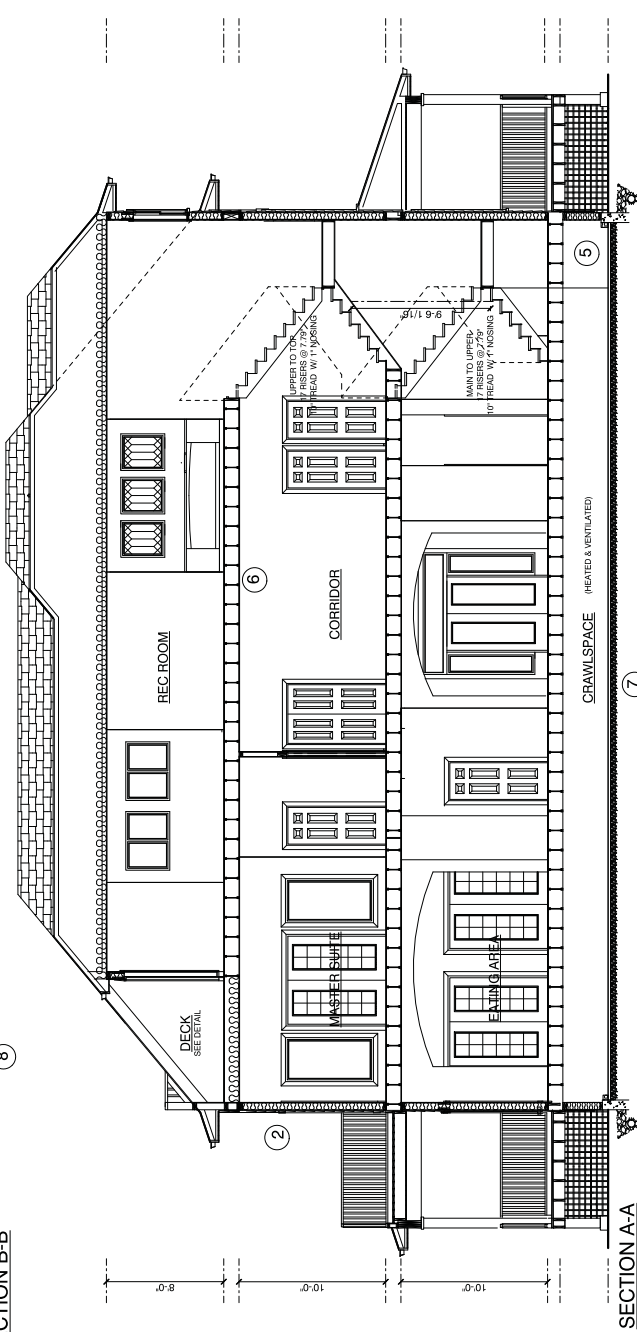

- 1 TYPICAL ROOF CONSTRUCTION:  
CEDAR ROOF SHINGLES  
W/ 2X4 CORNER TRIM  
1/2" POLYWOOD SHEATHING C/W EDGE CLIPS  
R-12 BATT INSULATION  
R-12 BATT INSULATION  
1/2" CEILING BOARD OR 5/8" G.W.B.
- 2 TYPICAL EXTERIOR WALLS:  
4" WOOD LAM SINKING  
W/ 2X4 CORNER TRIM  
- ONE EQUIVALENT MIN. 4" LAP  
3/8" POLYWOOD SHEATHING  
2X6 STUDS @ 16" O.C.  
R-12 BATT INSULATION  
6 MIL POLY V.B.  
1/2" G.W.B.
- 3 TYPICAL INTERIOR WALLS:  
2X6 STUDS @ 16" O.C.  
R-12 BATT INSULATION  
5/8" CONCRETE CURB  
FOUNDATION TO ENG. SPEC
- 4 TYPICAL CRAWLSPACE BEARING WALLS:  
2X6 STUDS @ 16" O.C.  
R-12 BATT INSULATION  
5/8" CONCRETE CURB  
FOUNDATION TO ENG. SPEC
- 5 TYPICAL CRAWLSPACE WALLS:  
2X4 STRAPPING C/W MIN  
R-12 BATT INSULATION  
R-12 BATT INSULATION  
1/2" G.W.B.
- 6 TYPICAL FLOOR SYSTEM:  
SELECTED FLOORING  
8" T & G PL WOOD SUB FLOOR  
2X2 CROSS BRIDGING @ MAX. 60" O.C.  
1/2" G.W.B.
- 7 TYPICAL CRAWLSPACE FLOOR:  
2X6 STUDS @ 16" O.C.  
R-12 BATT INSULATION  
MIN. 6" COMPACTED GRANULAR FILL  
PER ENGINEER'S DETAILS &  
SPECIFICATION
- 8 TYPICAL CRAWLSPACE BEARING WALLS:  
2X6 STUDS @ 16" O.C.  
R-12 BATT INSULATION  
5/8" CONCRETE CURB  
FOUNDATION TO ENG. SPEC

These drawings remain the property of Rusbourne Design Ltd and may not be reproduced without written consent from same.

THESE DRAWINGS CONFORM TO THE BC B.C. 2006 EDITION

- |   |   |   |  |
|---|---|---|--|
| 1 | TYPICAL EXTERIOR WALL:<br>CONCRETE FOUNDATION<br>1/2" STRAPPING<br>1/2" FLYWOOD SHEATHING C/W EDGE CLIPS<br>R-19 BATT INSULATION @ 16" O.C.<br>1/2" G.W.B.<br>1/2" CEILING BOARD OR 8/8" G.W.B. | 5 | TYPICAL EXTERIOR WALL:<br>CONCRETE FOUNDATION<br>1/2" STRAPPING<br>1/2" FLYWOOD SHEATHING C/W EDGE CLIPS<br>R-19 BATT INSULATION @ 16" O.C.<br>1/2" G.W.B. |
| 2 | TYPICAL EXTERIOR WALL:<br>10mm TRANSPIRENT MIN. 4" LAP<br>W/1/2" CONNER TRIM<br>INSULATION BAFFLE<br>PAVE WITH BUILDING PAPER<br>2x6 STUDS @ 16" O.C.<br>R-20 BATT INSULATION<br>1/2" G.W.B.    | 6 | TYPICAL GARAGE FLOOR:<br>4" CONCRETE FLOOR SLAB<br>MIN. 6" COMPACTED GRANULAR FILL<br>PAVE TO S/G. TO DRAIN  |
| 3 | TYPICAL INTERIOR WALL:<br>2x4 STUDS @ 16" O.C.<br>1/2" G.W.B. BOTH SIDES  | 7 | TYPICAL FOUNDATION:<br>TO ENGINEER'S SPECIFICATION   |
| 4 | TYPICAL BEARING WALLS:<br>2x6 STUDS @ 16" O.C.<br>1/2" G.W.B. BOTH SIDES<br>FOUNDATION TO ENG. SPEC.  |   |  |

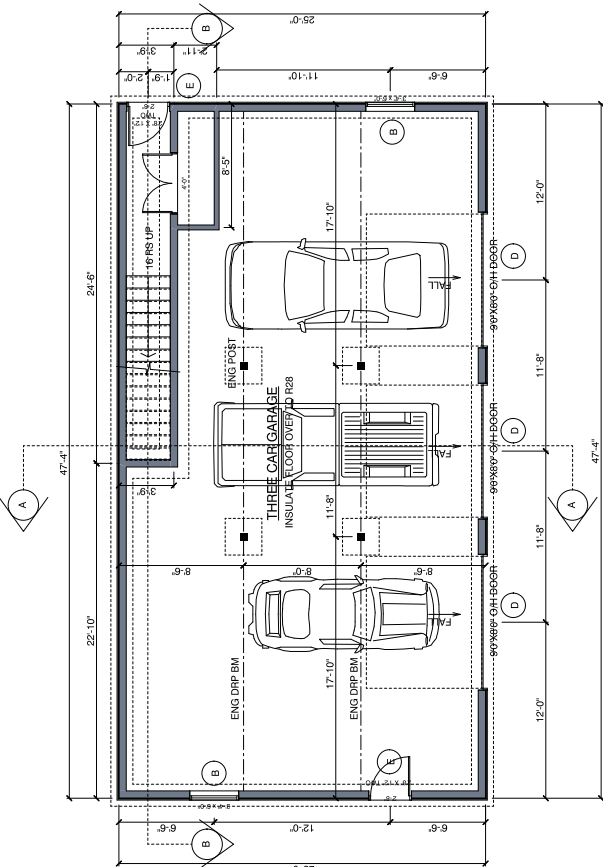
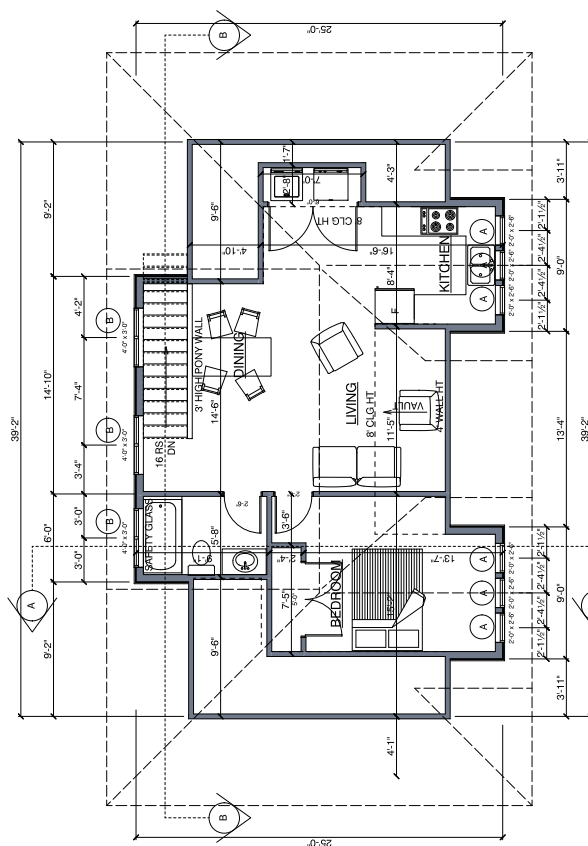
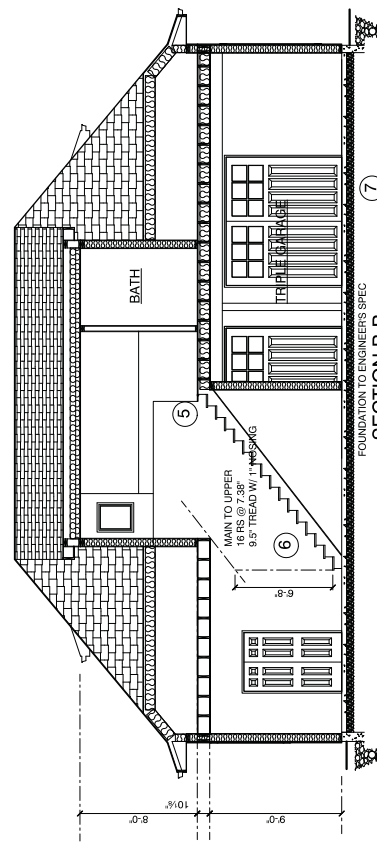
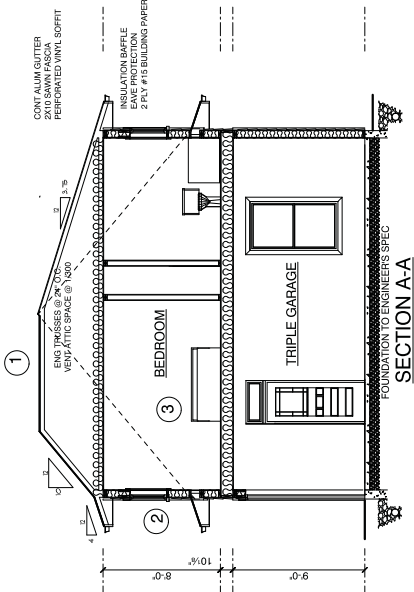

**RUSBOURNE DESIGN LTD**  
 2225 HARTLEY AVENUE,  
 FRODOBANK C. V3K 6W9  
 TEL: 604-598-3441  
 email: info@rusbournedesigns.com

PROJECT  
 13951 CRESCENT RD  
 SURREY, B.C.

SHEET TITLE  
**GARAGE PLANS**

DATE: June 21, 2012  
 DRAWN: S.G.  
 CHECKED: B.R.  
 SCALE: 1/4" = 1'0"

PLAN NUMBER  
**GARAGE**

SHEET NUMBER  
**G1**

REVISIONS

These drawings remain the property of Rusbourne Design Ltd and may not be reproduced without written consent from same.

**THESE DRAWINGS CONFORM TO THE BC B.C. 2006 EDITION**

WINDOWS TO SIMILAR HOUSE DORMER WINDOWS

PAINTED SPARKES

CEDAR ROOF SHINGLES TO MATCH HOUSE

8'-0" 3'-10" 9'-0"

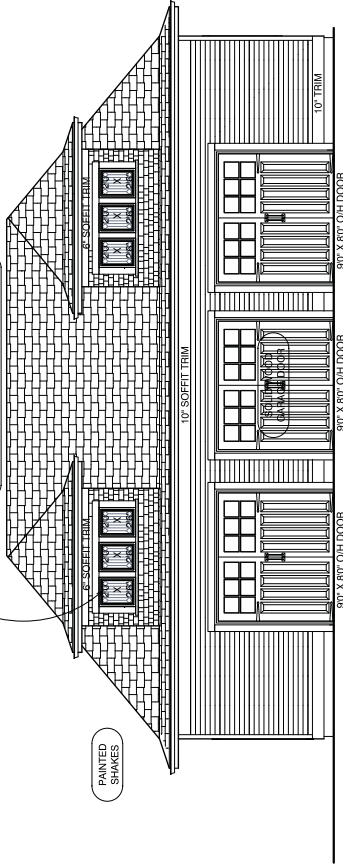

**WEST ELEVATION**

PROPOSED 1.38M 4.56'  
EXISTING 1.22M 4.00'

90 X 80 O/H DOOR  
90 X 80 O/H DOOR

PROPOSED 1.38M 4.56'  
EXISTING 1.53M 5.01'

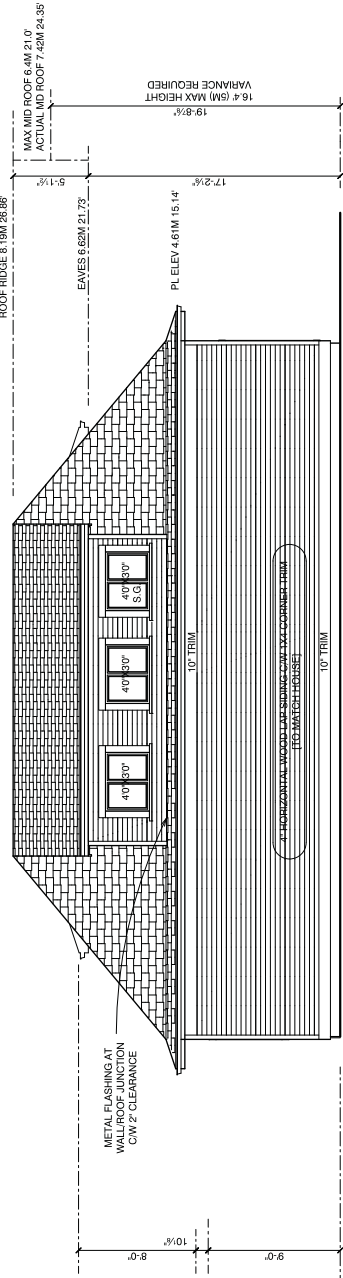

**EAST ELEVATION**

PROPOSED 1.38M 4.56'  
EXISTING 1.56M 5.12'

PROPOSED 1.38M 4.56'  
EXISTING 1.31M 4.30'

NOTE: ALL SOFFITS INCLUDING PORCHES & EAVES ARE NARROW PROFILE WOOD V-JOINT SOFFITS HERRING BONE CORNERS TO MATCH HOUSE

DOUBLE GLAZED WOOD FRAMED 80\"/>

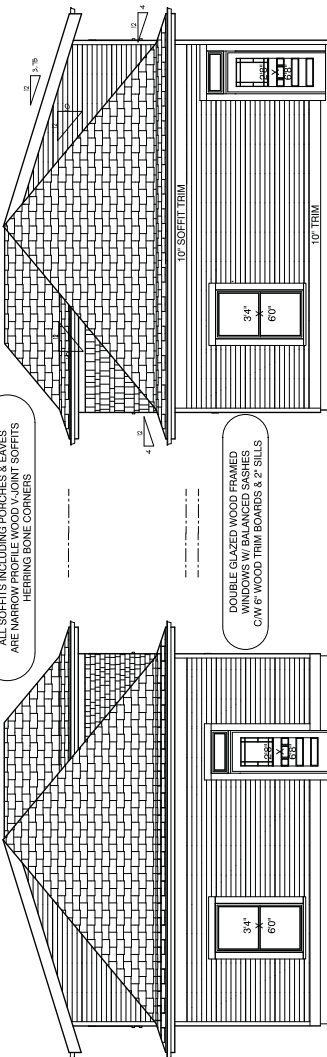

**NORTH ELEVATION**

**SOUTH ELEVATION**

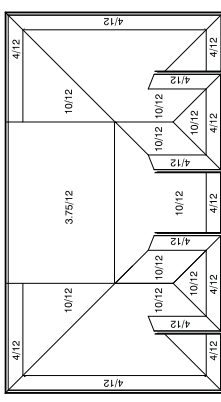

**ROOF PLAN**

ROOF RIDGE 8.19M 26.86'  
MAX MID ROOF 6.4M 21.0'  
ACTUAL MID ROOF 7.52M 24.35'  
19.8%  
16.4 (6M) MAX HEIGHT VARIANCE REQUIRED  
5'-1 1/2"  
17'-2 1/2"  
PL ELEV 4.61M 15.14'  
AVG FIN GRADE 1.40M 4.61'

**REVISIONS**

**RUSBOURNE DESIGN LTD**  
2225 HARTLEY AVENUE,  
COQUITLAM, B.C. V3K 6W9  
TEL: 604-526-7444  
email: info@rusbourndesigns.com

**PROJECT**  
13951 CRESCENT RD  
SURREY, B.C.

**SHEET TITLE**  
GARAGE ELEVATIONS

**DATE** June 21, 2012  
**DRAWN** S.G.  
**CHECKED** B.R.  
**SCALE:** 1/4" = 1'

**PLAN NUMBER**  
GARAGE  
**SHEET NUMBER**  
G2

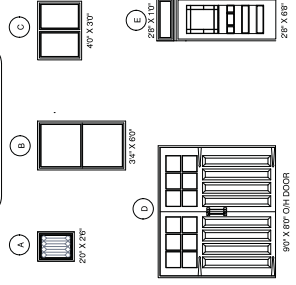

**WINDOW/DOOR SCHEDULE**

DOUBLE GLAZED WOOD FRAMED DOORS & CASEMENT WINDOWS WITH BALANCED SHAKES

These drawings remain the property of Rusbourne Design Ltd and may not be reproduced without written consent from same.

**THESE DRAWINGS CONFORM TO THE BC B.C. 2006 EDITION**

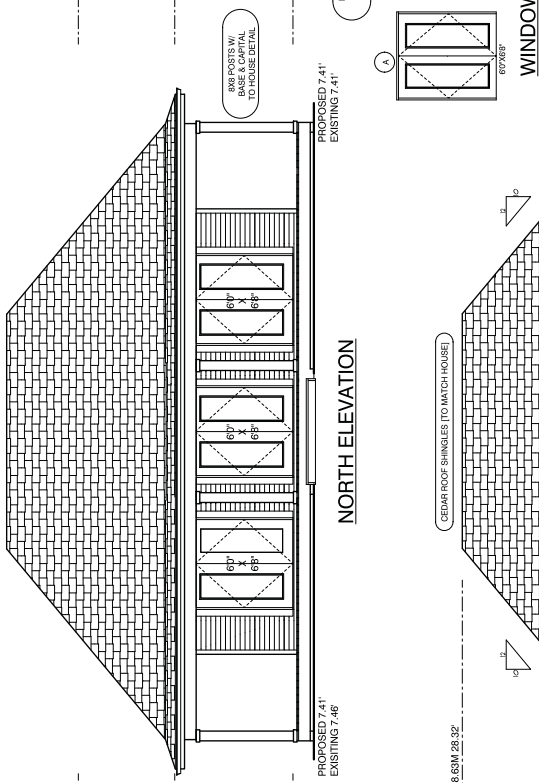

**RUSBOURNE DESIGN LTD**  
 2225 HARTLEY AVENUE  
 COQUITLAM, B.C. V3K 6W9  
 TEL: 604.526.7444  
 email: info@rusbourndesigns.com

**PROJECT**  
 13951 CRESCENT RD  
 SURREY, B.C.

**SHEET TITLE**  
 POOL HOUSE

**DATE** June 21, 2012  
**DRAWN** S.G.  
**CHECKED** B.R.  
**SCALE:** 1/4" = 1'  
**PLAN NUMBER**  
 POOL HOUSE  
**SHEET NUMBER**  
 PH

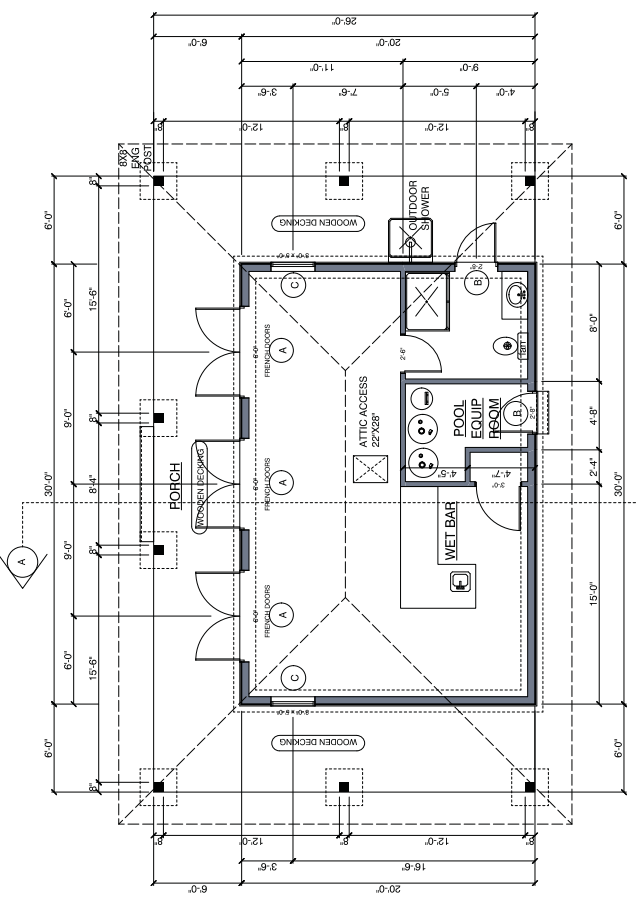

**FLOOR PLAN 600 SQ FT 55.74 SQ FT**

- 1 TYPICAL ROOF CONSTRUCTION:  
 CEDAR ROOF SHINGLES  
 3X2 STRIPPINGS  
 1/2" PLYWOOD SHEATHING CW EDGE CLIPS  
 R-4 BATT INSULATION  
 1/2" CEILING BOARD OR 5/8" G.W.B.
- 2 TYPICAL EXTERIOR WALLS:  
 10mm TRANS-PREEN MIN. 4" LAP  
 OR EQUIVALENT  
 3/8" PLYWOOD SHEATHING  
 R-20 BATT INSULATION  
 5/2" G.W.B.
- 3 TYPICAL INTERIOR WALLS:  
 1/2" G.W.B. 8'0" H SIDES
- 4 TYPICAL FLOOR SYSTEM:  
 SELECTED FLOORING  
 5/8" T & G PLYWOOD SUB FLOOR  
 2"x2" CROSS BRIDGING @ MAX. 8'0" O.C.
- 5 TYPICAL FOUNDATION:  
 TO ENGINEERS SPECIFICATION

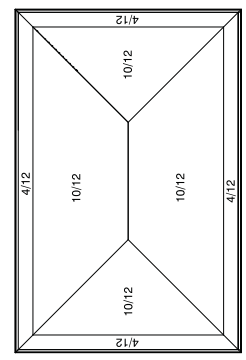

**ROOF PLAN**

NOTE:  
 ALL SOFFITS INCLUDING PORCHES & EAVES  
 ARE NARROW FRAMED WOOD JOINT SOFFITS  
 WITH INTEGRAL LEDGERS

DOUBLE GLAZED VINYL FRAMED  
 WINDOWS W/ BALANCED SASHES  
 CW 6" WOOD TRIM BOARDS & 2" SILLS

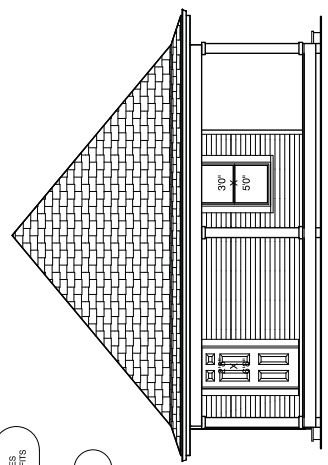

**WEST ELEVATION**

**EAST ELEVATION**

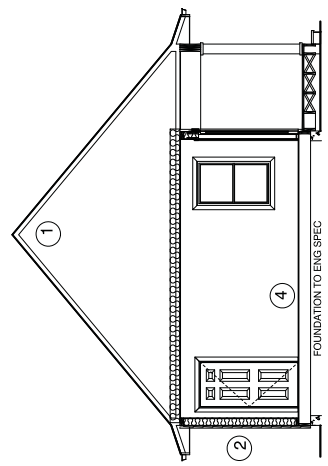

**SECTION AA**  
 FOUNDATION TO ENG SPEC



Location Map: 13951 Crescent Road

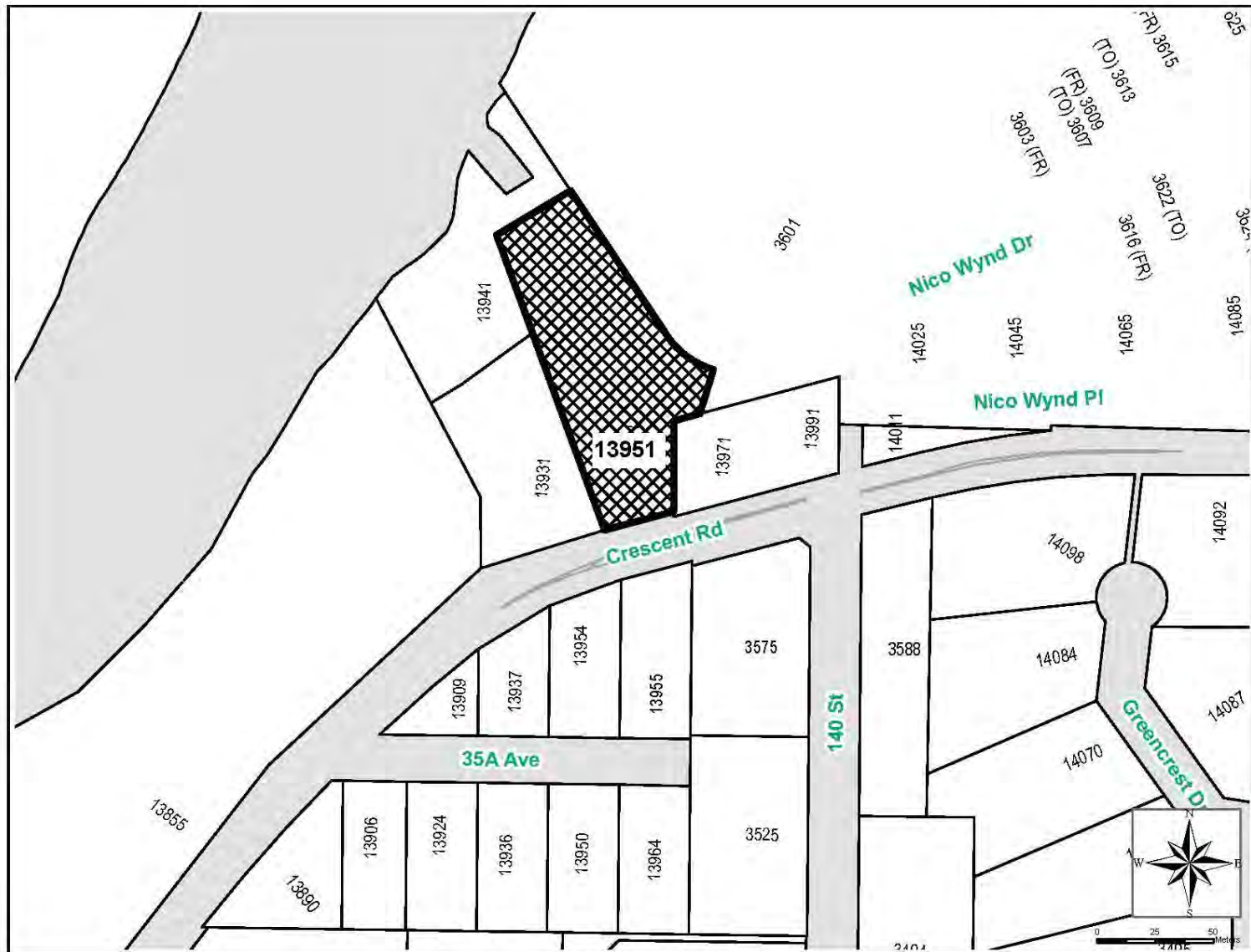

CITY OF SURREY

BY-LAW NO. 14203

A by-law to enter into a heritage revitalization agreement  
.....

WHEREAS:

- A. The Council may by by-law pursuant to Part 27 of the Local Government Act, R.S.B.C. 1996, Chapter 323, as amended, re-enacted or consolidated from time to time and any successor statute, enter into a heritage revitalization agreement with the owner of heritage property.
  
- B. The Council considers that certain lands and premises situate within the City described as:

That portion of the following:

Parcel Identifier: 005-179-009  
Lot 28, District Lot 157, Group 2, New Westminster District, Plan 53898

(Portion of 13951 Crescent Road)

shown hatched on a Subdivision Plan prepared by Peter Mueller, B.C.L.S. (which hatched portion has been added to the Subdivision Plan) and containing 6,650 square metres, and attached hereto as Schedule "1" and forming a part of this By-law

(the "Lands")

have heritage value and heritage character and ought to be conserved.

- C. The Owner of the Lands and the City of Surrey have agreed on the nature, character and extent of the heritage value and heritage character of the Lands and on the nature, extent and form of conservation necessary to protect the heritage value and heritage character.

NOW THEREFORE, the City Council of the City of Surrey, in open meeting assembled, enacts as follows:

1. The City Council is authorized hereby to enter into that certain Heritage Revitalization Agreement including Schedules “A” and “B” attached thereto and appended to this By-law as Schedule “2”, (the “Heritage Revitalization Agreement”) in respect of the Lands.
2. The Mayor and the City Clerk are authorized on behalf of the Council to sign and seal the Heritage Revitalization Agreement.
3. Schedules “1” and “2” form a part of this By-law.
4. The City Clerk is directed to insert the legal description for the Lands in this By-law once title has been issued to the same. The new legal description of the Lands shall be as follows:

Parcel Identifier: \_\_\_\_\_

Lot 2, District Lot 57, Group 2, New Westminster District

Plan LMP \_\_\_\_\_

4. This By-law may be cited for all purposes as “Surrey Heritage Revitalization Agreement By-law, 2000, No. 14203.”

READ A FIRST AND SECOND TIME on the 4th day of December, 2000.

PUBLIC HEARING HELD thereon on the 19th day of February, 2001.

READ A THIRD TIME on the 26th day of February, 2001.

RECONSIDERED AND FINALLY ADOPTED, signed by the Mayor and Clerk, and sealed with the Corporate Seal on the 24th day of March, 2003.

\_\_\_\_\_  
MAYOR

\_\_\_\_\_  
CLERK

h:\by-laws\adopted bylaws\2003\clk14203.blw.doc

# SCHEDULE "1"

[To City of Surrey Heritage Revitalization Agreement By-law, 2000, No. 14203]

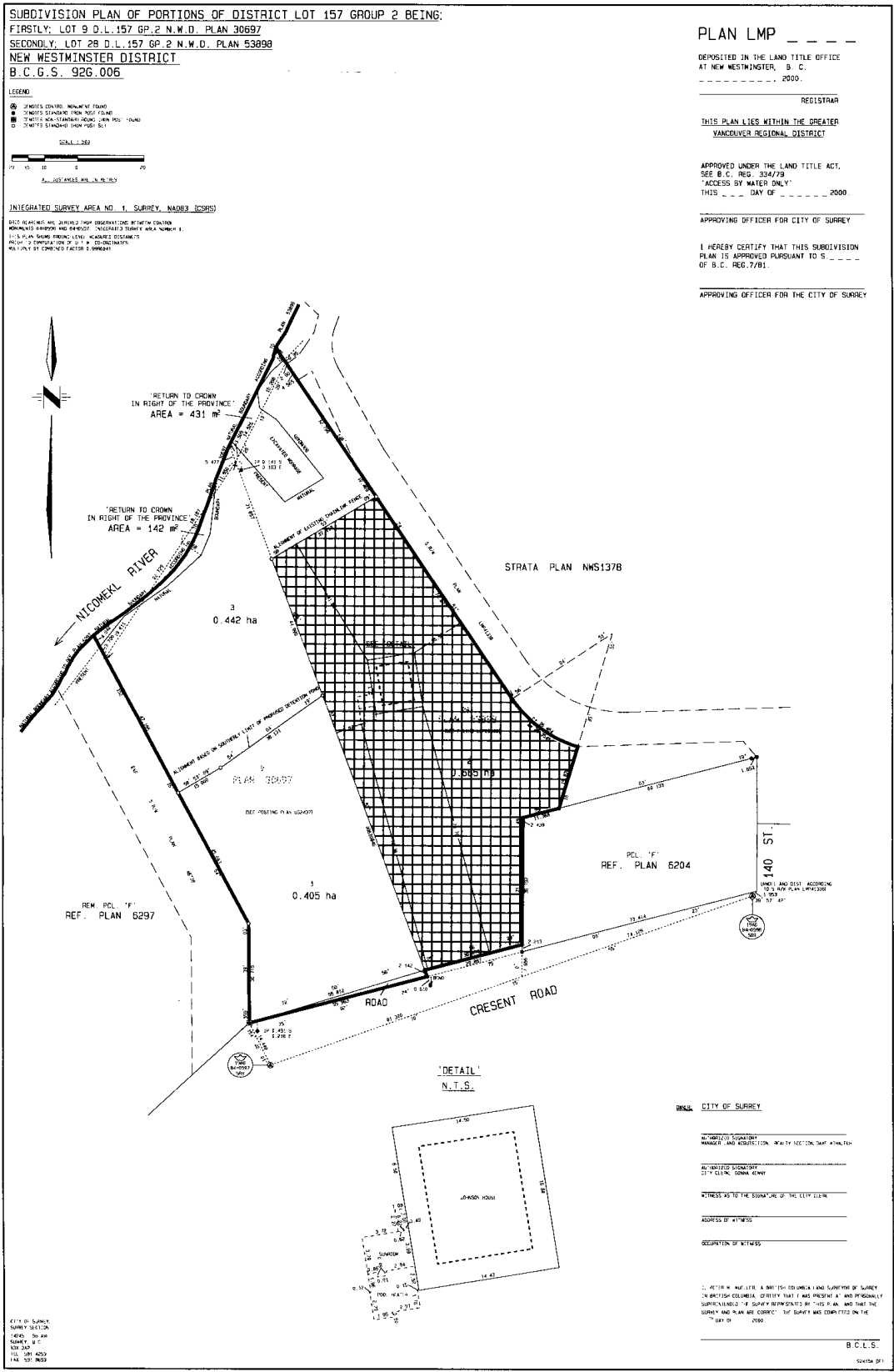

## SCHEDULE "2"

[To City of Surrey Heritage Revitalization Agreement By-law, 2000, No. 14203]

### HERITAGE REVITALIZATION AGREEMENT

This Agreement made the 24th day of March, 2003

BETWEEN:

CITY OF SURREY  
Realty Section, Engineering Department  
7452 - 132 Street  
Surrey, British Columbia,  
V3W 4M7

(the "Owner")

OF THE FIRST PART

AND:

CITY OF SURREY  
14245 - 56 Avenue  
Surrey, British Columbia,  
V3X 3A2

(the "City")

OF THE SECOND PART

WHEREAS:

- A. The Owner is the registered owner in fee simple of the following lands and premises situate in the City of Surrey, British Columbia and described as:

Parcel Identifier: 005-179-009

Portion of Lot 28, District Lot 157, Group 2, New Westminster District, Plan 53898 shown in heavy outline on a Survey Plan attached hereto and forming a part of this By-law, certified correct by Peter Mueller, B.C.L.S., on the 26th day of July, 2000, containing 0.665 hectares and called Block „A“, as identified on page A-13 of this Agreement.

(Portion of 13951 Crescent Road)

(the "Lands")

- B. The Owner and the City consider that the Lands have *heritage value* and *heritage character*.
- C. The Owner and the City desire to conserve the *heritage value* and *heritage character* of the Lands.
- D. For the purpose of conservation of the *heritage value* and *heritage character*, the Owner and the City have agreed to enter into this Agreement setting out the terms and conditions of continuing protection for the *heritage value* and *heritage character* of the Lands.
- E. The improvements on the Lands which have *heritage value* and *heritage character* which both the Owner and City desire to conserve have been described by text, photographs and survey plans attached as Schedule “A” (the “Conservation Plan”) to this Agreement.
- F. The single family dwelling identified on the Conservation Plan as the Daniel Johnson House (the “Johnson House”) is listed on the Surrey Heritage Register.

NOW THEREFORE THIS AGREEMENT WITNESSES that in consideration of the mutual premises of the parties hereto and for other good and valuable consideration (the receipt and sufficiency of whereof is hereby by the parties acknowledged) the Owner and the City covenant and agree with one another pursuant to Section 966 of the Local Government Act, R.S.B.C., 1996, Chapter 323, as amended, re-enacted or consolidated from time to time and any successor statute (the “Local Government Act”), as follows:

Conservation Plan

- 1. (a) The Conservation Plan forms a part of this Agreement and to the extent that the text, photographs, plans and drawings constituting the Conservation Plan require interpretation, the City shall determine the matter and Section 15 of this Agreement shall apply; and
- (b) Part I of the Conservation Plan identifies, details and describes the character, extent and nature of the improvements to be placed on the Lands that have *heritage value* and *heritage character*. Part II of the Conservation Plan provides for the timing and phasing of, and sets out standards and specifications for, relocation, restoration, rehabilitation, replication, repair, replacement or maintenance to be undertaken and completed pursuant to this Agreement. Part III of the Conservation Plan sets out restrictions, requirements, guidelines and exemptions for the *conservation* and maintenance of all improvements on the Lands that have *heritage value* and *heritage character*, in addition to any necessary future construction.

## Owner's Obligations to Conserve and Maintain

2. The Owner covenants and agrees that:
  - (a) no improvements on the Lands identified in the Conservation Plan as having *heritage value* or *heritage character* shall be *altered* including alterations required or authorized by this Agreement, except as agreed to by the City;
  - (b) each action of relocation, restoration, rehabilitation, replication, repair, replacement or maintenance, required by Part II of the Conservation Plan, shall be commenced and completed in accordance with the timing, phasing, standards and specifications set out in Part II of the Conservation Plan;
  - (c) all improvements identified in Part I of the Conservation Plan as having *heritage value* and *heritage character* shall be maintained to the minimum standards and in accordance with the guidelines and requirements set out in Part III of the Conservation Plan;
  - (d) all those undeveloped areas of the Lands outside the restricted building envelope as outlined on the “Tree Survey Plan With Restricted Building Envelope” on page A-16 and forming part of the Conservation Plan, being lands in the opinion of the City necessary for the *conservation* of proximate improvements, identified in the Conservation Plan as having *heritage value* and *heritage character*, shall continue to remain free of all development and shall be kept in their landscaped and cultivated state, as required in and in accordance with the guidelines set out in Part III of the Conservation Plan, and without limiting the generality of the foregoing, the elevation and configuration of the land shall not be altered, and no trees or landscaping shall be removed or cut, except for reasonable pruning and grooming as specified in Schedule “E” of Tree Preservation By-law, 1996, No. 12880, as amended;
  - (e) in the event that the Johnson House is more than 50% destroyed by fire, explosion or other natural catastrophe, it shall be reconstructed in a massing and style similar to, but not necessarily identical to, the existing Johnson House, and notwithstanding all provisions of Surrey Zoning By-law, 1993, No. 12000, as amended, any restrictions or relaxations provided by this Agreement to the Lands shall apply. The design of the reconstructed house shall capture the original design components of the Johnson House, including but not limited to the roof pitch, roofing material, roof lines including gables, wood cladding, window style and placement, wrap-around porch, and location of entrances; and
  - (f) the Owner shall do or cause to be done all such things, and shall take or cause to be taken all such actions as are necessary to ensure that the restrictions and requirements provided in Subsections (a), (b), (c), (d) and (e) of this Section 2 are fully observed, and the Owner shall not do, cause



or allow to be done anything that would be in breach of the restrictions herein.

### Variation of By-laws

3. Pursuant to Section 966 (2) (b) of the Local Government Act, the following by-laws of the City are varied and supplemented in their application to the Lands in the manner and to the extent provided as follows:
  - (a) Section D of Part 12, One-Acre Residential Zone (RA) of City of Surrey Zoning By-law, 1993, No. 12000, as amended, is hereby amended as set out in Section I of Schedule "B" which is incorporated hereto and forms part of this Agreement as it relates to the Lands;
  - (b) Section F of Part 12, One-Acre Residential Zone (RA) of City of Surrey Zoning By-law, 1993, No. 12000, as amended, is hereby amended as set out in Section II of Schedule "B" which is incorporated hereto and forms part of this Agreement as it relates to the Lands; and
  - (c) Section K of Part 12, One-Acre Residential Zone (RA) of City of Surrey Zoning By-law, 1993, No. 12000, as amended, is hereby amended as set out in Section III of Schedule "B" which is incorporated hereto and forms part of this Agreement as it relates to the Lands.

### Construction and Maintenance

4. Wherever in this Agreement the Owner relocates, restores, rehabilitates, replicates, repairs, replaces, maintains or in any way *alters* improvements on, or features of the Lands identified in the Conservation Plan as having *heritage value* and *heritage character* or constructs or maintains other works to protect or conserve such improvements or features, all such work shall be done at the Owner's sole expense strictly in accordance with the Conservation Plan and as agreed by the City and all improvements or features shall be diligently and continuously maintained in good repair and efficient operating condition by the Owner at the Owner's sole expense in accordance with good engineering, design, heritage and *conservation* practice.

### No Liability to City

5. In no case shall the City be liable or responsible in any way for:
  - (a) any personal injury, death or consequential damage of any nature whatsoever, howsoever caused, that be suffered or sustained by the Owner or by any other person who may be on the Lands; or
  - (b) any loss or damage of any nature whatsoever, howsoever caused to the Lands or any improvements or personal property thereon belonging to the Owner or to any other person;

arising directly or indirectly from compliance with the restrictions and requirements herein, wrongful or negligent failure or omission to comply with restrictions and requirements herein, or refusal, omission or failure of the City to enforce or require compliance by the Owner with the restrictions or requirements herein or with any other term, condition or provision of this Agreement.

#### Reasonable Care and Risk

6. The Owner shall at all times, in complying with the restrictions or requirements herein and its obligations in respect thereof, take reasonable care not to injure any person or cause or allow damage to any property, and shall take reasonable care not to cause, suffer, permit or allow any condition to exist that might reasonably lead to, cause or result in injury to any person or property including persons and property on adjacent lands. It shall be the sole responsibility of the Owner to comply and maintain compliance with the restrictions and requirements herein in a safe manner, and without reasonably foreseeable risk to person or property as aforesaid. Compliance with the restrictions and requirements in this Agreement shall be at the sole and exclusive risk of the Owner.

#### Modification

7. If, in fulfilling its responsibilities and obligations pursuant to this Agreement, the Owner perceives or becomes aware of any unreasonable risk of injury to persons or damage to property or other potential loss that cannot be reasonably avoided, alleviated, reduced or eliminated except by measures that would be a breach of the restrictions, requirements or its obligations herein, the Owner shall notify the City in writing of the nature and extent of the risk and of the measures proposed by the Owner to be undertaken at its sole cost to reduce, alleviate, avoid or eliminate the risk. Risk shall remain with the Owner.

#### Indemnity

8. The Owner shall at all times indemnify and save harmless the City of and from all loss and damage, and all actions, claims, costs, demands, expenses, fines, liabilities and suits of any nature whatsoever by whomsoever brought for which the City shall or may become liable, incur or suffer by reason of existence and effect whether direct or indirect of the restrictions or requirements herein, or breach or nonperformance by the Owner of any covenant, term or provision hereof, or by reason of any work or action of the Owner in performance of its obligations hereunder, or by reason of any wrongful act or omission, default or negligence of the Owner.

### Alternative Remedies

9. Any performance by the City pursuant to a statutory right to perform the obligations of an Owner arising out of this Agreement may be exercised fully in accordance with the Local Government Act, and shall be without prejudice to any and all other remedies at law and equity available to the City, and no reference herein to, or exercise of any specific right or remedy by the City, shall preclude the City from exercising any other right or remedy.

### Damages

10. The Owner covenants and agrees that the measure of damages for any breach of the restrictions or requirements of this Agreement shall include, but shall not be limited to, the actual cost and expense of all administration, labour, materials, equipment, services and work required for all remedial acts necessary to fully relocate, restore, rehabilitate, replace, repair or maintain the building, structure, improvements on or features of the Lands having *heritage value* and *heritage character* to be protected, conserved, preserved or kept in its natural state. The nature and extent of any breach of the said restrictions and requirements, and the nature and extent of any relocation, restoration, rehabilitation, replacement, maintenance or remedial work or action of any nature required to remedy such breach shall be determined by the City by reference to the Conservation Plan, and Sections 2 and 3 of this Agreement.

### No Waiver

11. No restrictions, requirements or other provisions in this Agreement shall be deemed to have been waived by the City unless a written waiver authorized by resolution of the Council and signed by an officer of the City has first been obtained, and without limiting the generality of the foregoing, no condoning, excusing or overlooking by the City on previous occasions of any default nor any previous written waiver shall be taken to operate as a waiver by the City of any subsequent default or in any way to defeat or affect the rights of remedies to the City.

### Statutory Authority and Proprietary Rights

12. Nothing in this Agreement shall limit, impair, fetter, or derogate from the statutory powers of the City all of which powers may be exercised by the City from time to time and at any time to the fullest extent that the City is enabled and no permissive by-law enacted by the City, or permit, license or *approval*, granted, made or issued thereunder, or pursuant to statute, by the City shall estop, limit or impair the City from relying upon and enforcing this Agreement.

### Compliance with Laws

13. Despite any provision of this Agreement, the Owner shall comply with all laws, including by-laws of the City and all regulations and orders of any authority having jurisdiction, and to the extent only that such laws, regulations and orders are mandatory and necessarily require the breach of any restriction or positive

obligation herein to be observed or performed by the Owner, or less than strict compliance with the terms hereof, then the Owner upon sixty (60) days' written notice to the City shall be excused from complying with such restrictions or performing such obligation and such restriction or obligation shall be suspended but only to the extent and for the time that such mandatory law, regulation or order is inconsistent with compliance with the said restrictions or obligations.

#### Notice

14. Any notice to be given hereunder shall be in writing and may be either delivered personally or sent by prepaid registered mail and if so mailed shall be deemed to have been given five (5) days following the date upon which it was mailed. The address of the parties for the purpose of notice shall be as follows:

If to the City:

Attention: City Clerk  
City of Surrey  
14245 - 56 Avenue  
Surrey, B.C. V3X 3A2

If to the Owner:

Attention: General Manager, Engineering  
City of Surrey  
Realty Section, Engineering Department  
7452 - 132 Street  
Surrey, B.C. V3W 4M7

Any party hereto may at any time give notice in writing to the other of any change of address and after the third day of giving of such notice, the address therein specified shall be the address of such party for the giving of notices hereunder.

#### Arbitration

15. The Owner, if dissatisfied with the City's interpretation of the Conservation Plan and any determination pursuant to Section 1(a) of this Agreement may require that the matter be decided and determined by binding arbitration as follows:
- (a) the Owner must, within thirty (30) days of any exercise of discretion by the City, give notice to the City of its intention to dispute and in such notice shall name a member in good standing of the Architectural Institute of British Columbia who has agreed to act as an arbitrator;
  - (b) the City shall within thirty (30) days of receipt of the aforesaid notice either accept the Owner's arbitrator, or name another with the same qualifications willing to act, and shall give notice of the same to the Owner;

- (c) where each of the Owner and the City have named an arbitrator, the two arbitrators shall within thirty (30) days of the City's notice pursuant to this Section 15(b) appoint a third arbitrator having the same qualifications and the three arbitrators shall decide the dispute;
  - (d) where the City accepts the arbitrator first selected by the Owner, that arbitrator shall act as a single arbitrator and forthwith decide the dispute; and
  - (e) any arbitrator's decision in respect of the exercise of a discretion by the City shall be final, conclusive and binding on all parties.
16. Without limiting the City's power of inspection conferred by statute and in addition thereto, the City shall be entitled at all reasonable times and from time to time to enter onto the Lands for the purpose of ensuring that the Owner is fully observing and performing all of the restrictions and requirements in this Agreement to be observed and performed by the Owner, and wherever possible, when an inspection of the lands is undertaken, the City shall provide reasonable notice to the Owner.

#### Headings

17. The headings in this Agreement are inserted for convenience only and shall not affect the construction of this Agreement or any provision hereof.

#### Schedules

18. All schedules to this Agreement are incorporated into and form part of this Agreement.

#### Number and Gender

19. Whenever the singular or masculine or neuter is used in this Agreement, the same shall be construed to mean the plural or feminine or body corporate where the context so requires.

#### Interpretation

20. Terms used in this Agreement that are italicized are defined in the Local Government Act, and the Heritage Conservation Act, R.S.B.C. 1996, Chapter 187, as amended, re-enacted or consolidated from time to time and any successor statute, and shall take their meaning from those Acts.

#### Successors Bound

21. All restrictions, rights and liabilities herein imposed upon or given to the respective parties shall extend to and be binding upon their respective heirs, executors, administrators, successors and assigns. When the Owner is more than one party they shall be bound jointly and severally by the terms, covenants and agreements herein on the part of the Owner.

Notice to be Filed

22. Notice of this Agreement and amendments to it will be filed in the Land Title Office and once filed, this Agreement and amendments will be binding on all persons who acquire an interest in the Lands

IN WITNESS WHEREOF the Owner and the City have executed this Agreement as of the date first above written.

CITY OF SURREY )  
)  
)  
)  
)  
)  
)  
\_\_\_\_\_)  
Dave Mihalech )  
Manager, Realty Services )

The Corporate Seal of )  
CITY OF SURREY )  
was hereunto affixed in the )  
presence of: )  
)  
)  
)  
)  
\_\_\_\_\_)  
Acting City Clerk )

## **SCHEDULE "A"**

### **Conservation Plan**

#### **Part I - Historical and Architectural Background**

The Daniel Johnson House is identified on the photographs dated April 1998 and May 2000, and a Surveyors Certificate of Location dated July 24, 2000, attached to and forming part of this Agreement.

The Johnson House was built around 1904, and designed in an Edwardian style, the common style of the post-Victorian era. It was built on the property located at 14107 Crescent Road on a bank overlooking the Nicomekl River. It was owned by Daniel Johnson until the 1950's, when it was sold to Norman Cryer. More recently, Ryan Walter, a former member of the Vancouver Canucks, owned the property from 1991 to 1994.

Daniel Johnson was one of South Surrey's earliest pioneers. He homesteaded in Mud Bay on the Serpentine River in 1880, and 1882, began a dairy operation. In 1887, he purchased the southwest quarter section of Lot 33 on the north bank of the Nicomekl River from John Chantrell, after whom Chantrell Creek is named. Johnson's dairy operation continued to expand, and in 1903, he purchased the property on which the House is located from Chantrell. He had the House built shortly after expanding the farm, and Frederick Biggs did much of the carpentry work. Daniel Johnson served several unspecified years on the Municipal Council. He died in 1925, and his wife died in 1936.

The property was redeveloped in 1977 as part of the Nico Wynd townhouse and golf course development, and the Johnson House was moved further west to a new lot as shown on the Air Photograph on Page A-12 and the Surveyors Certificate of Location on Page A-15 of this Agreement. The placement of the House was similar to its original: the front faced south-east and in its relocated position it faces approximately due east. A cluster of conifer trees is located at the front of the property and a row of willow trees extend along the east side of the property as identified on the Tree Survey on Page A-16 of this Agreement.

The plan of the Johnson House is nearly square. Typical of Edwardian design, the overall mass resembles a box with exterior walls with minimal recesses, as shown on the photographs on page A-7 of this Agreement. A veranda wraps around the entire Johnson House, interrupted only by a newer sunroom extension at the rear. Given that the foundation is newer, the basement is a full size with poured concrete floor and walls. With the relocation, the Johnson House was raised significantly above grade to allow for a basement-level two-car garage on the north side. The main flared hipped roof is covered in asphalt shingles. The roofline has been altered to some extent, particularly with a prominent gable on the north. Two smaller gables extend from the front and rear. The porch posts do not appear to be original, as boards cover some other form of structural support for the veranda roof. The posts are presently painted black.

There were originally two chimneys, the main one for the living room and the other as a utility chimney for the kitchen. Both had to be removed when the Johnson House was relocated. The main chimney was reconstructed for the living room on the west side, while the utility chimney now consists of a stainless steel conduit projecting from the roof.

The Johnson House is clad in white vinyl siding and wood trim around windows. It is not known whether the original wood siding, likely narrow lap siding, is underneath. The single front door is flanked by two panels with square clear windows in the upper section. The door and panels have decorative elements such as a cornice and dentils. The windows of the House are primarily single vertical double hung with no muntins. The exceptions are the double hung windows set in pairs for the living room, the fixed single oriel window with a keystone motif in the window surround located on the second floor and the rectangular casement windows divided by muntins into a hexagon diamond pattern. These are shown on the photographs on pages A-7 and A-8 of this Agreement. These casement windows are located on the second floor, grouped into three at the front above the main entrance, and four individual windows along the rear. The two kitchen windows have also been replaced with casement windows, but with a frame similar to the double hung windows elsewhere in the Johnson House. The exterior sash frames are painted black.

The original tongue and groove flooring has been retained on the veranda, which is covered by a half hipped roof. The front steps leading up to the veranda are framed by the plain square veranda posts and a low peak gable extending out of the veranda roof. The veranda posts and balusters appear to have been replaced at some time. A secondary entrance is from the left side of the veranda into the kitchen.

The front entry opens on to a wide hallway, with a straight staircase located immediately to the left of the entrance. A parlour room is located to the right of the hall, and leads though to the living room at the rear. The kitchen occupies the other rear corner opposite the living room, with a separate pantry and newer bathroom. The dining room is at the front of the Johnson House to the left of the hall. At one time, access to the dining room may have been from the hall, but now the only access is through the kitchen. The stairs lead to a similarly wide hallway on the second floor. The floor is divided up into roughly equal quarters for four bedrooms, and the main bathroom is located at the rear left corner. It features a clawfoot tub, a pedestal sink and a separate toilet room. A door is located at the end of the upper hall leading to a deck. A narrow stairway, enclosed by a door, leads from the upper hall to the third floor. This has been completed in more recent times and includes a large whirlpool tub and a small deck.

The most prominent interior features include pocket doors separating the parlour room from the living room, decorative cast iron water radiators in the living room, main hall and upper hall, transom windows above the bedroom and main bathroom doors, and original doors and door hardware for the bedrooms and bathroom.

The restrictions and requirements pertaining to the Lands are limited to the structure and exterior of the Johnson House, a future detached garage, any other future accessory building, and fencing and landscaping.

## Part II - Standards and Specifications of Restoration and New Construction

### 1. Foundation of House

As part of this Agreement, the Johnson House may be moved from its present foundation to a new concrete foundation on the same lot. Alternatively, the Johnson House may be raised and placed down on a new concrete foundation on the same site. In either case, the location



of the Johnson House on the Lands is restricted by the setbacks for the One-Acre Residential Zone as specified in Schedule “B” of this Agreement, in addition to all other City by-laws.

If the Johnson House is placed on a new foundation, the new elevation shall be lower than the existing elevation, and the foundation shall not extend more than 1 metre (3 ft.) above the finished grade. If a basement is accommodated in the new foundation, it shall not be evident from the exterior. In addition, if the House is placed on a new foundation, a garage shall not be retained within the perimeter of the House. A new garage must be detached from the House. (See Section 3 of this Part below.)

## 2. Structure and Exterior of House

The existing roofing material shall be removed and the roof shall be covered with new materials, limited to treated edge-cut cedar shingles. Any fascia boards showing signs of decay shall be replaced, and all fascia boards shall be painted prior to installing eaves troughs. The eaves troughs and downspouts attached to the lower roof shall be examined and replaced if necessary, and eaves troughs and downspouts shall be attached to the fascia board on the upper roof. The eaves troughs shall be a seamless pre-finished aluminum gutter of O-Gee profile and the downspouts shall be pre-finished aluminum, preferably circular profile.

The front porch and overhang, including all flooring, supports, cladding and other design features shall be retained. The porch posts may be removed and replaced with a square solid wood post. The floorboards that are showing any sign of decay shall be replaced with tongue and groove or wood planks of an identical profile. Where the balustrade shows signs of decay and cannot be repaired, it shall be replaced with identical wood pieces. The wood railing leading down from the porch to the pool area on the south side, and the wood stairs leading up to the front porch at the main entrance shall be replaced with a wooden stair and hand railing.

The main chimney on the west side of the Johnson House shall be reinforced or rebuilt using red brick, and in a manner so that it is identical to the original chimney in terms of location, design and height, as identified in the attached photographs.

## 3. New Garage and Accessory Building

In the event that the Johnson House is placed on a new foundation in accordance with the terms noted in section 1 of this Part, a detached one-car or two-car garage shall be constructed in accordance with the requirements for an accessory building specified in Schedule “B” of this Agreement.

The garage shall be of a style identical to the Johnson House. This includes, but is not limited to, a roof peak running lengthwise along the garage, flared roof ends, roofing material, eaves troughs, downspouts and associated fascia.

The garage shall be clad with wood lap siding. The garage door is to be of solid wood construction, either double batten doors, or single-car conventional wooden garage doors on tracks and rollers. Windows shall be provided on at least two sides of the garage. The windows shall appear similar to the double hung windows of the Johnson House. The

assembly of these windows, however, shall be either double or single hung, hopper, casement or fixed. The colour of the siding for the garage is to be similar to or complementary to the colour of the Johnson House.

In the event that the Johnson House is not placed on a new foundation, construction of a detached one-car or two-car garage is optional. However, if it is constructed it shall be designed in accordance with the requirements specified above, and in accordance with the terms specified in Schedule “B” of this Agreement.

#### 4. Interior of House

Selected features of the interior of the Johnson House are shown on the photographs on pages A-8, A-9, A-10 and A-11 of this Agreement. The interior of the Johnson House will not be affected by these additions, and no restoration, rehabilitation, replication, repair, replacement or maintenance of the interior will be mandatory as part of this Agreement. However, this Agreement encourages the owner to retain those original or early interior components that contribute to heritage character of the Johnson House. These components include:

- the staircase, newel posts, newel caps, railing and balusters
- the original doors and door hardware and related features such as transom windows above the bedroom doors and second floor bathroom door
- pocket doors separating the living room and front parlour
- decorative cast iron radiators in the living room, main hall and second floor hall
- wood flooring
- baseboards and trim around doors and windows

#### 5. Timing of Restoration and New Construction

*Scenario ‘A’ - The Johnson House is placed on a new foundation (as specified in item 1 of this Part):*

The restoration, rehabilitation, replication, repair, replacement and construction specified in items 2 and 3 of this Part shall be completed within 18 months from the date that the House is on the new foundation.

*Scenario ‘B’ - The Johnson House remains on its existing foundation:*

The restoration, rehabilitation, replication, repair, replacement and construction specified in item 2 of this Part shall be completed within 18 months from the date of completion of sale of the Lands by the City to a new owner. Under this scenario, there is no timing requirement for item 3 of this Part, since it is optional. However, if within this 18-month timeframe, the new owner decides to place the House on a new foundation, the timing requirements of Scenario „A“ above shall then apply.

There is no timing requirement on item 4 of this Part.

#### 6. Review and Approval

Building plans of all relocation, restoration, rehabilitation, replication, repair, replacement and construction associated with items 1, 2 and 3 of this Part of the Conservation Plan will

require referral to the General Manager, Planning & Development and the Heritage Advisory Commission for review and approval.

### Part III - Continued Maintenance, Protection and Future Construction

#### 1. General

Wherever possible, original exterior features of the Johnson House shall be retained. If any original features must be replaced, the new material shall be identical to the original. Where original features were removed through earlier renovations or alterations, and the replacements were not in keeping with the original style of the building, any subsequent replacement of these exterior features shall complement the building's heritage style.

The Johnson House shall be maintained to prevent water intrusion and damages from sun, wind, weather, animals and vandalism. This includes the replacement of roofing when necessary, and painting to protect exterior features. The trees identified in the Tree Survey Plan on page A-16 this Agreement shall be maintained in accordance with the Tree Preservation By-law, 1996, No. 12880, as amended.

The construction or alteration of any improvements on the Lands so as to create a secondary suite or suite of any kind whether for use by the owner or otherwise shall not be permitted.

All rehabilitation, replication, repair, replacement, maintenance and construction associated with this Part of the Conservation Plan will require referral to the General Manager, Planning & Development and the Heritage Advisory Commission for review.

#### 2. Foundation of House

The option remains in the future to place the Johnson House on a new foundation on the existing site or relocate the House to another part of the Lands. This shall be undertaken following the terms specified in item 1 of Part II of this Agreement. New construction shall also be in accordance with Schedule "B" attached to and forming part of this Agreement and as illustrated on the Restricted Building Envelope on page A-16 of this Agreement.

#### 3. Structure and Exterior of House

The windows on the Johnson House shall be retained. In the event that any windows and exterior doors must be replaced due to aging or deterioration of materials, the replacement shall be identical to the original in terms of style, shape and assembly. The owner is encouraged to install removable wood frame storm windows to protect the original windows and to insulate the House.

The vinyl cladding on the Johnson House may be removed. If it is removed, it shall be determined whether the original wood cladding is underneath, and if so whether it is possible to retain it. If it is necessary to replace the cladding, it shall be identical in appearance and profile to the original horizontal lap siding.

In the event that the white vinyl cladding is replaced, the Johnson House may be re-painted with a colour that is in keeping with its historical style. This shall be in consultation with the Heritage Advisory Commission. In the event that the original siding remains underneath the vinyl siding, a more in-depth examination of any previous layers of paint will be necessary. The windows, doors and associated trim may be of a contrasting complementary colour.

The sunroom located on the west side of the Johnson House may be removed on the condition that the portion of the wrap-around porch that had been removed is restored in accordance with the specifications of item 2 of Part II of the Conservation Plan.

4. Garage and Accessory Buildings

If the option to construct a garage or another accessory building is not undertaken within the timing specified in Part II of this Agreement, any future construction shall follow the terms and conditions specified in item 3 of Part II of the Conservation Plan.

5. Fencing

The existing fence style should be retained. If it is replaced, it may be a low profile heritage-style fence. The fence styles most appropriate to complement the heritage character of the Crescent Road corridor include picket, three board, split rail and contemporary rail. Other acceptable styles include welded wire fence made of wood posts and wire mesh screened by a hedge, and low natural stone walls. Examples of fence types and the height restrictions for each fence type are as follows:

| Type of Fence                   | Maximum Height     |
|---------------------------------|--------------------|
| Picket and Contemporary Picket  | 1.1 metre (3.5 ft) |
| Three Board                     | 1.2 metre (4 ft.)  |
| Contemporary Rail               | 1.1 metre (3.5 ft) |
| Hedge with Wire Mesh            | 1.1 metre (3.5 ft) |
| Split Rail (Straight or Angled) | 1.2 metre (4 ft.)  |
| Stone                           | 1.0 metre (3 ft.)  |

Examples of heritage-style fences and dimensions are provided on pages A-17 and A-18 of this Agreement.

6. Landscaping

Landscaping is preferred as an alternative to typical perimeter fencing. Indigenous plant materials are recommended to augment the historical character of Crescent Road. The area of the Lands outside the Restricted Building Envelope shall be retained in its landscaped and cultivated state.

The trees identified on the Tree Survey on Page A-16 of this Agreement shall be retained in their natural state. The removal of any of these trees shall require an assessment by an I.S.A.-accredited arborist confirming that the tree is a hazard, and a tree cutting permit issued by the City. To protect the cluster of conifers at the front, relocation or widening of the existing driveway within the Restricted Building Envelope shall not be permitted.

Photographs of Exterior of Daniel Johnson House (April 1998):



House as seen from river frontage, featuring wrap-around porch and window arrangement on second floor including oriel window on north side and single casement windows on east side flanking the chimney. Third floor balcony is a more modern addition.



House as seen from driveway featuring triplet window arrangement on second floor above main entrance. Double garage on north side under wrap-around porch is a more modern addition.



South side of House, with modern sunroom addition on west side (left of photograph).



Detailing of single casement bathroom windows on south-east side of House, as seen from the second floor balcony.

Photographs of Interior of Daniel Johnson House (May 2000):



Staircase leading from main hall.



Details of staircase woodwork, including newel post and newel cap.



Living room with decorative cast iron radiator and fireplace.



Living room looking into front parlour (pocket doors are fully open).



Front parlour with a view through to the living room, with pocket doors dividing the two rooms.



Main floor hall of House, with main entry door flanked by decorative panels.



Second floor hall of House, with stairs framed by newel post, balustrade, and square balusters. Other features include fir floor, decorative cast iron radiator and triplet window arrangement at front.





Stairs leading to third floor, with a plain newel post.



Second floor bedroom and bathroom door with clear transom windows.

Air Photo Showing Original Location of Johnson House, Dated April 30, 1954



# Survey Plan of Proposed New Lot to Accommodate Johnson House

SURVEY PLAN TO ACCOMPANY SURREY HERITAGE REVITALIZATION AGREEMENT  
 BYLAW NUMBER \_\_\_\_\_ OF A PORTION OF LOT 28 DISTRICT LOT 157  
 GROUP 2 N.W.D. PLAN 53898  
 B.C.G.S. 926.006

**LEGEND**

- 1910'S CONTROL MONUMENT FOUND
- 1940'S CONTROL MONUMENT FOUND
- 1960'S CONTROL MONUMENT FOUND
- CONTROL MONUMENT FOUND

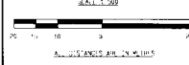

**INTEGRATED SURVEY AREA NO. 1, SURREY NAD83 (CSRS)**

THIS PLAN IS BASED ON THE 1910'S CONTROL MONUMENT FOUND IN THE AREA DESCRIBED IN BYLAW NO. 2480/06 AND 2481/06. THE INTEGRATED SURVEY AREA NUMBER IS 1.  
 THIS PLAN SHOWS THE 1910'S CONTROL MONUMENT FOUND IN THE AREA DESCRIBED IN BYLAW NO. 2480/06 AND 2481/06. THE INTEGRATED SURVEY AREA NUMBER IS 1.  
 ALL DISTANCES ARE IN METERS.

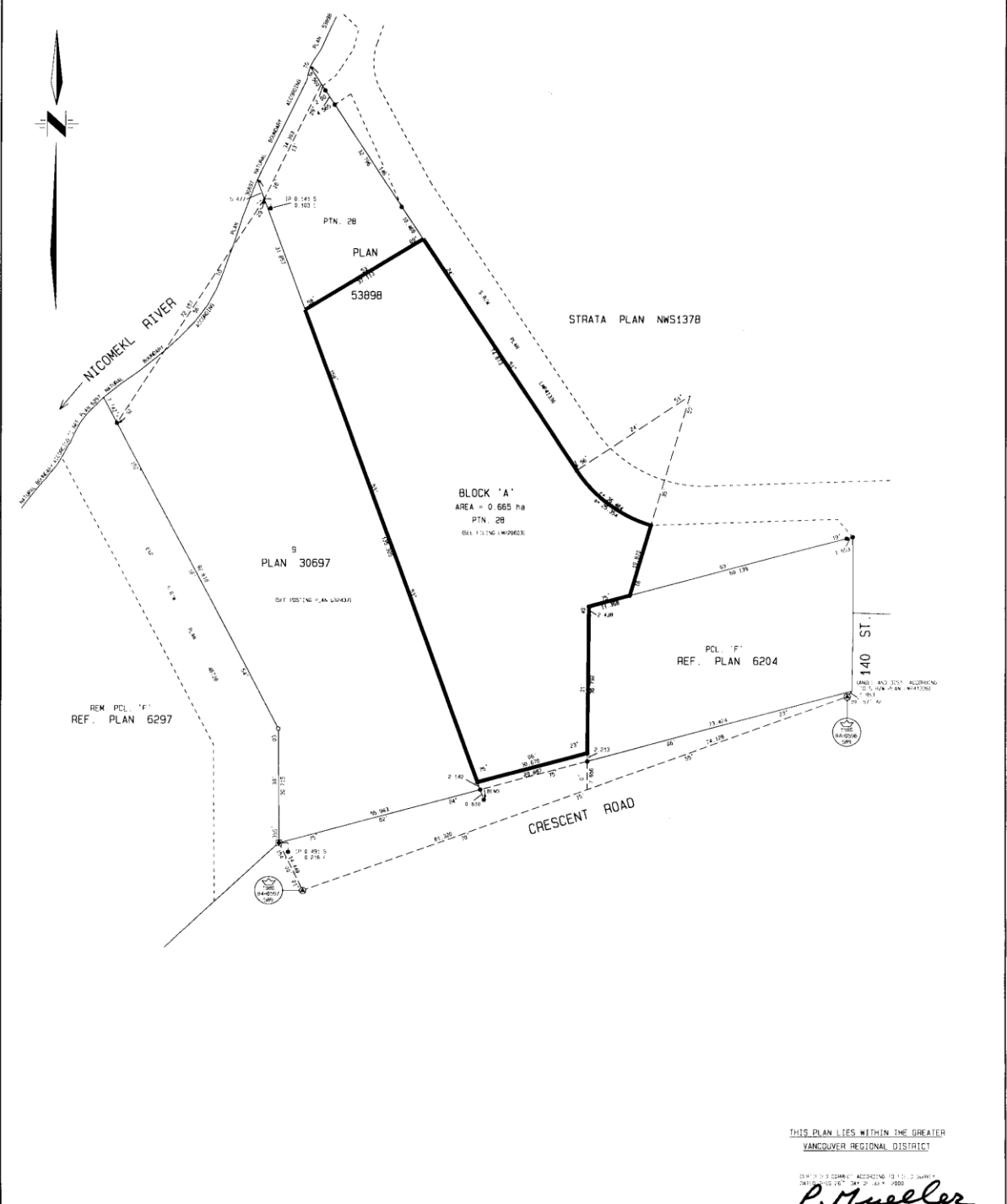

THIS PLAN LIES WITHIN THE GREATER VANCOUVER REGIONAL DISTRICT

DATE: 10/15/06  
 DRAWN BY: P. Mueller

# Proposed Subdivision and Location of Johnson House

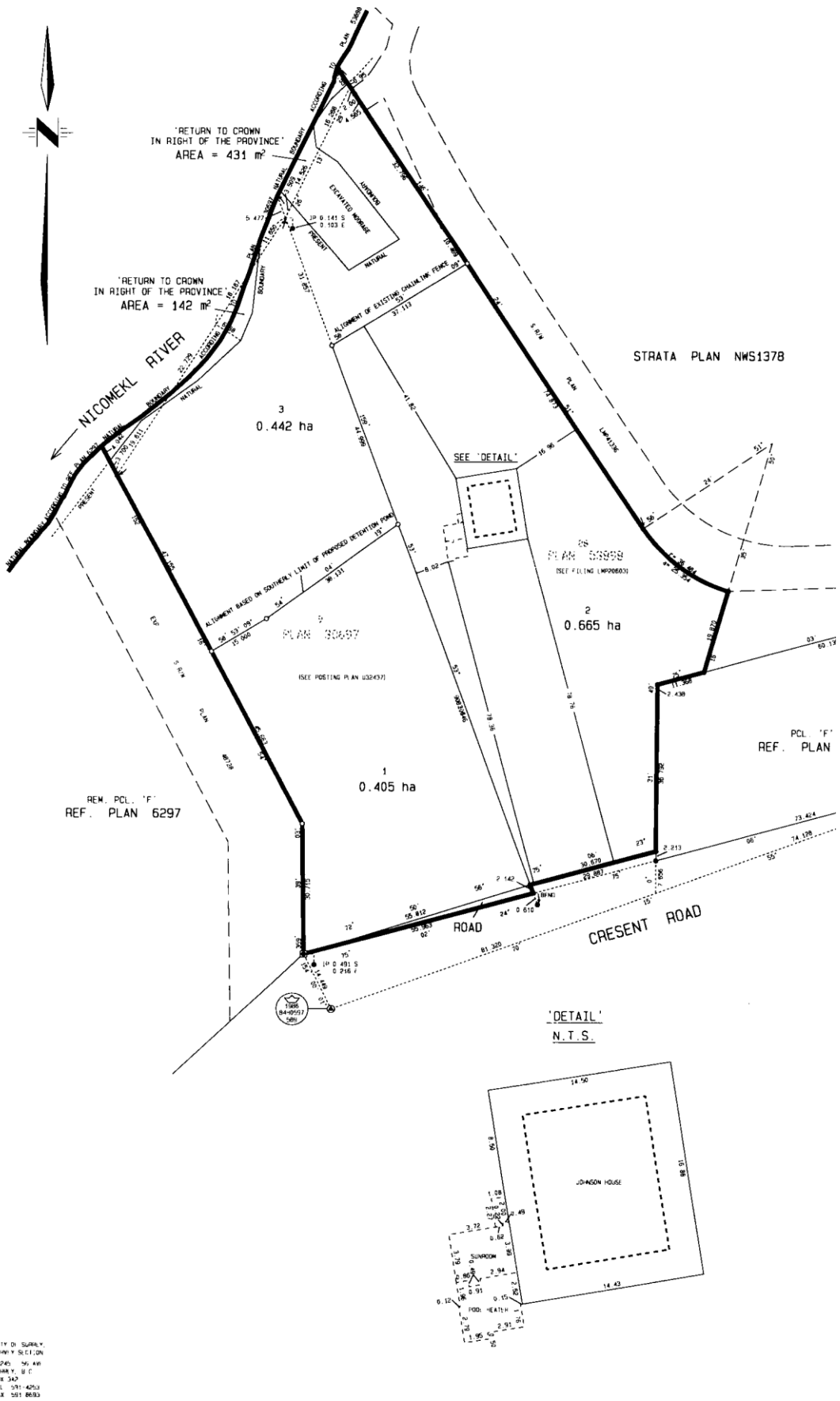

CITY OF SUDBURY  
 SURVEY SECTION  
 24240 36' 40"  
 SUDBURY, B. C.  
 V38 342  
 711 381 4203  
 43 581 8693

Surveyors Certificate of Location Dated July 24, 2000

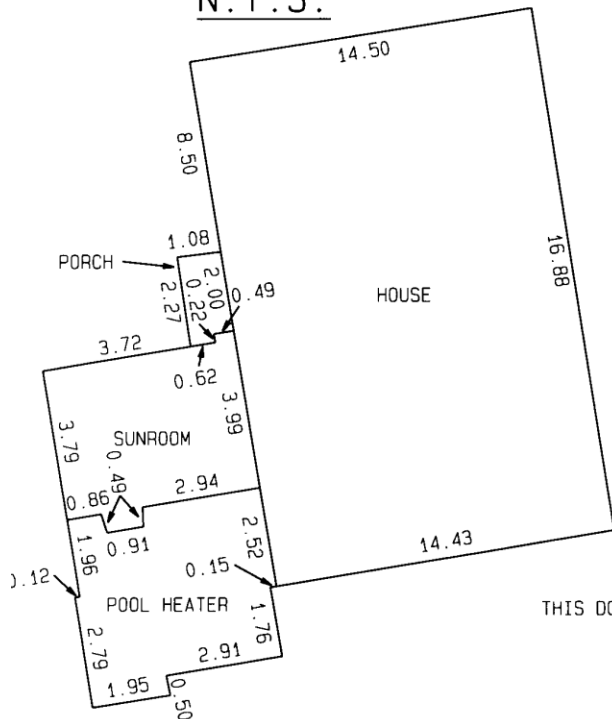
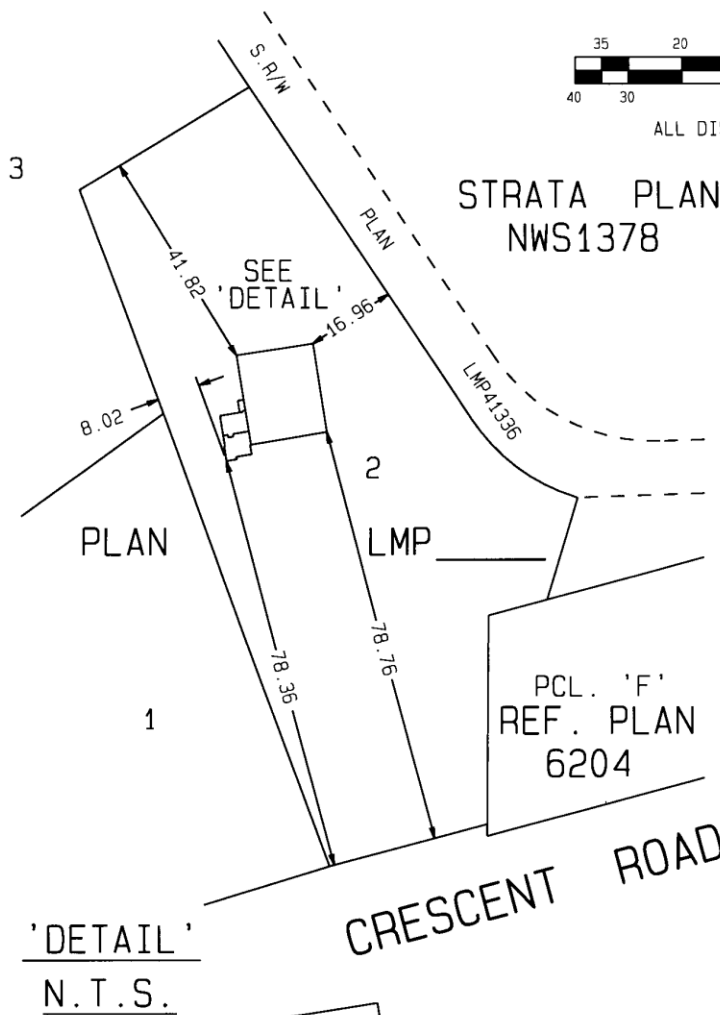
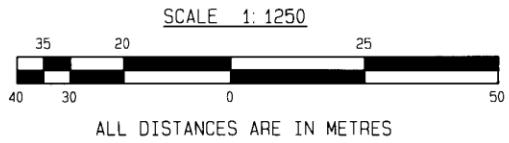

THIS DOCUMENT IS NOT VALID UNLESS ORIGINALLY SIGNED AND SEALED  
CERTIFIED CORRECT THIS 24TH DAY OF JULY 2000.

*P. Mueller*

B.C.L.S.

# Tree Survey Plan With Restricted Building Envelope, Dated August 8, 2000

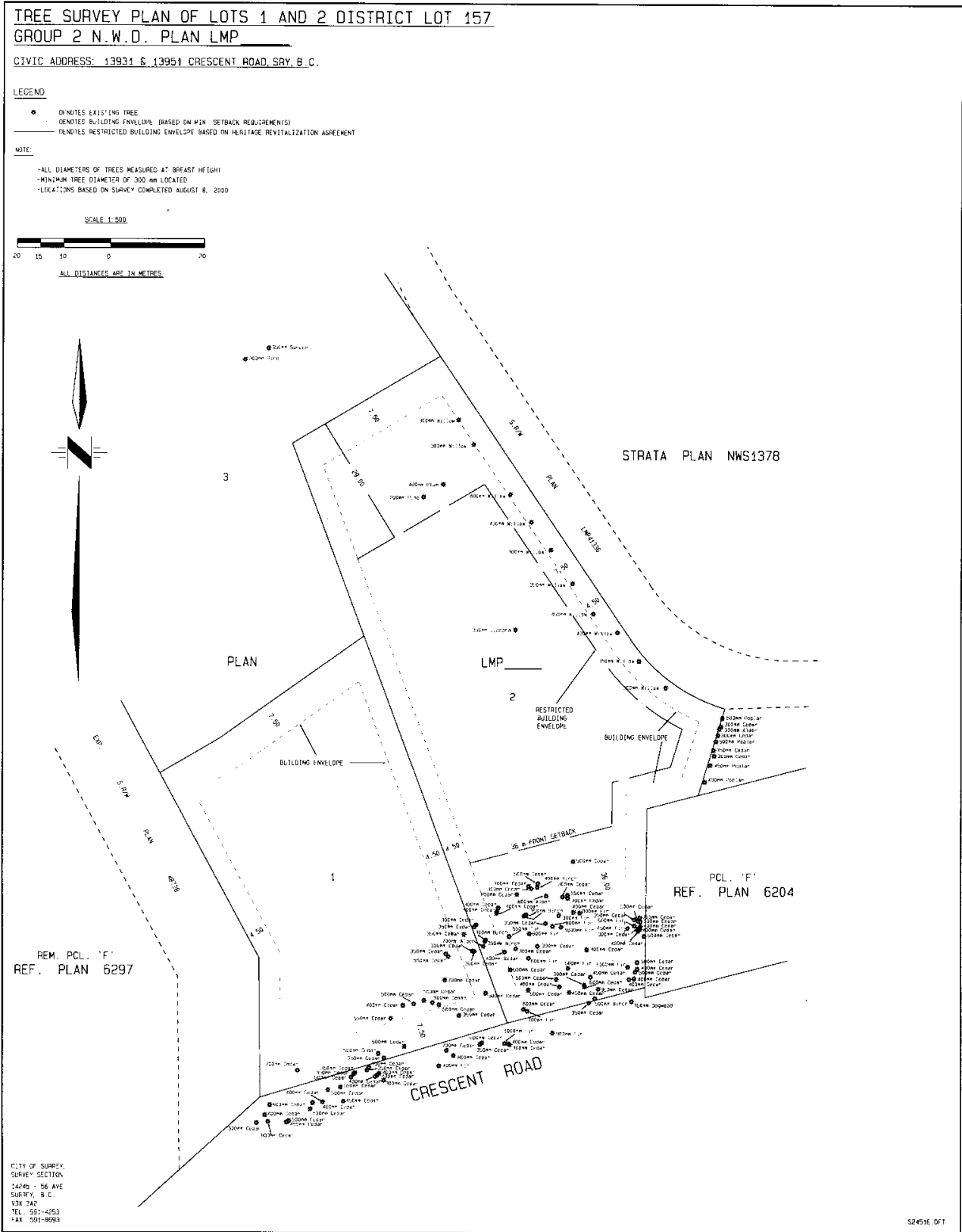

# Examples of Fence Types

## Picket

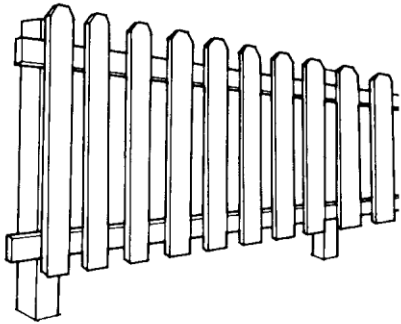
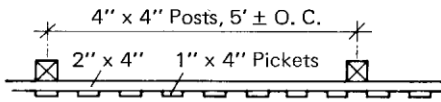

## Contemporary Picket

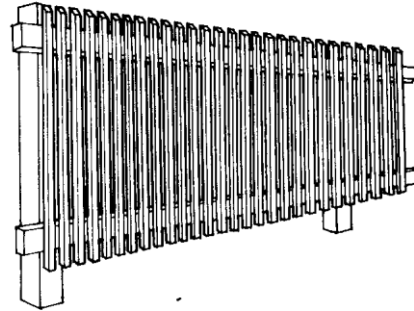
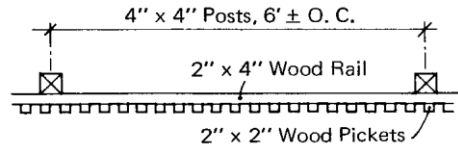

## Three Board

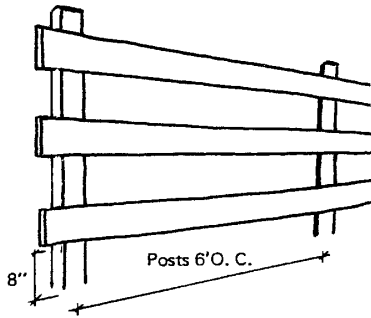
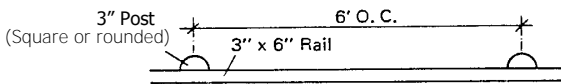

## Contemporary Rail

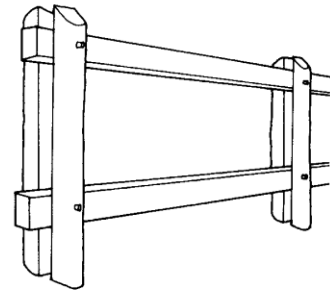
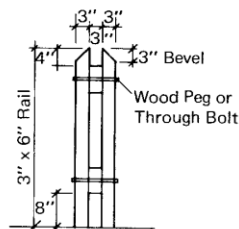
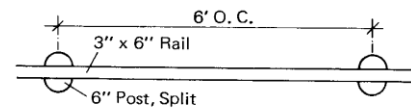

## Hedge with Wire Mesh Fence

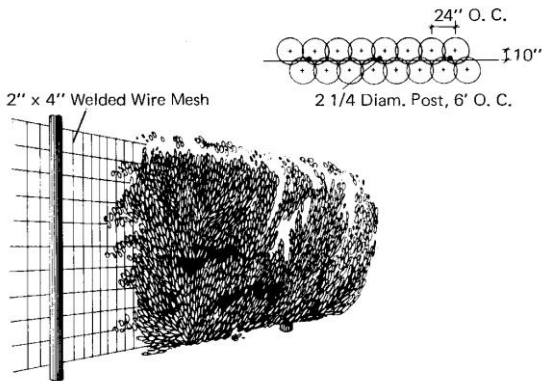

---

Straight Split Rail

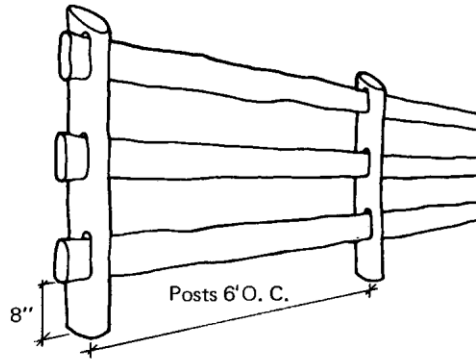

Angled Split Rail

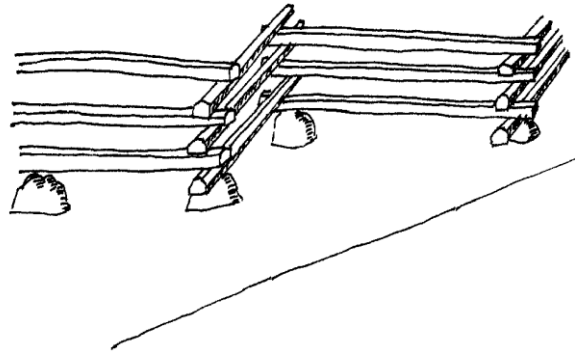



## SCHEDULE "B"

1. Part 12, One-Acre Residential Zone (RA) of City of Surrey Zoning By-law, 1993, No. 12000, as amended, is hereby amended only with respect to the Lands as follows:

**I. Section D, Density, is replaced with the following:**

“For *building* construction within a *lot*, the *floor area ratio* shall not exceed 0.056, provided that, of the resulting allowable floor area, a maximum of 325 square metres [3,500 sq.ft.] shall be reserved for the *principal building*, and 50 square metres [540 sq.ft.] shall be reserved for use only as a garage to be detached from the *principal building*. The floor area making up *accessory buildings* or *structures* that are each equal to or less than 10 square metres [105 sq.ft.] shall not be included as part of the floor area for the purpose of calculating *floor area ratio*.”

**II. Section F, Yards and Setbacks, is replaced with the following:**

“1. *Buildings* and *structures* shall be sited in accordance with the following minimum *setbacks*:

| Use  | <i>Setback</i> | <i>Front Yard</i>    | <i>Rear Yard</i>    | <i>West Side Yard</i> | <i>East Side Yard</i> |
|--|----------------|----------------------|---------------------|-----------------------|-----------------------|
| <i>Single Family Dwelling</i>  |                | 36.0 m.<br>[120 ft.] | 29.0 m.<br>[95 ft.] | 4.5 m.<br>[15 ft.]    | 7.5 m<br>[25 ft.]     |
| <i>Buildings and Structures For Uses Permitted Under Sec. B.2* of this Zone</i>  |                | 36.0 m.<br>[120 ft.] | 29.0 m<br>[95 ft.]  | 7.5 m.<br>[25 ft.]    | 7.5 m.<br>[25 ft.]    |
| <i>Accessory Buildings and Structures Greater Than 10 square metres [105 sq.ft.] in Size, Other than for Uses Permitted Under Sec. B.2* of this Zone</i> |                | 36.0 m.<br>[120 ft.] | 29.0 m<br>[95 ft.]  | 1.0 m<br>[3 ft.]      | 7.5 m<br>[25 ft.]     |
| <i>Other Accessory Buildings and Structures</i>  |                | 36.0 m.<br>[120 ft.] | 29.0 m<br>[95 ft.]  | 0.0 m.                | 7.5 m<br>[25 ft.]     |

Measurements to be determined as per Part 1 Definitions of Surrey Zoning By-law, 1993, No. 12000, as amended.

- \* These *setback* requirements for *hobby kennels* do not apply if the *hobby kennel* forms part of or is attached to the *single family dwelling*, however, the *hobby kennel* shall be located at the rear of the *single family dwelling*.”

**III. Section K, Subdivision, is replaced with the following:**

“*Lots* created through subdivision in this Zone shall conform to the following minimum standards:

| <i>Lot Size</i>         | <i>Lot Width</i>      | <i>Lot Depth</i>       |
|-------------------------|-----------------------|------------------------|
| 4,047 sq.m.<br>[1 acre] | 30 metres<br>[98 ft.] | 60 metres<br>[200 ft.] |

Dimensions shall be measured in accordance with Section E.21, Part 4  
General Provisions of Surrey Zoning By-law, 1993, No. 12000, as amended.

”

(Note: Terms used in Schedule “B” of this Agreement that are italicized are defined in Surrey Zoning Bylaw, 1993, No. 12000, as amended, and shall take their meaning from that By-law.)